

Lockout / Tagout

Hazardous Energy Control LOTO Devices

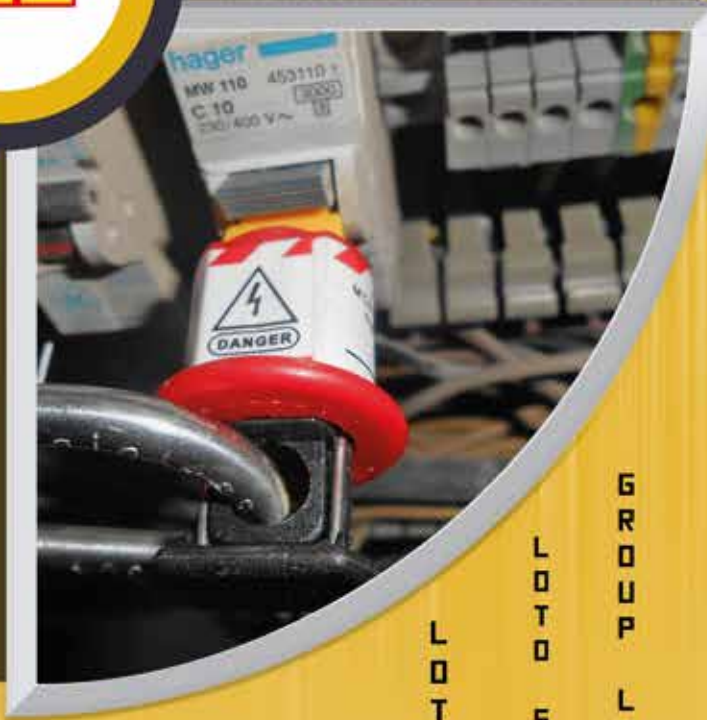
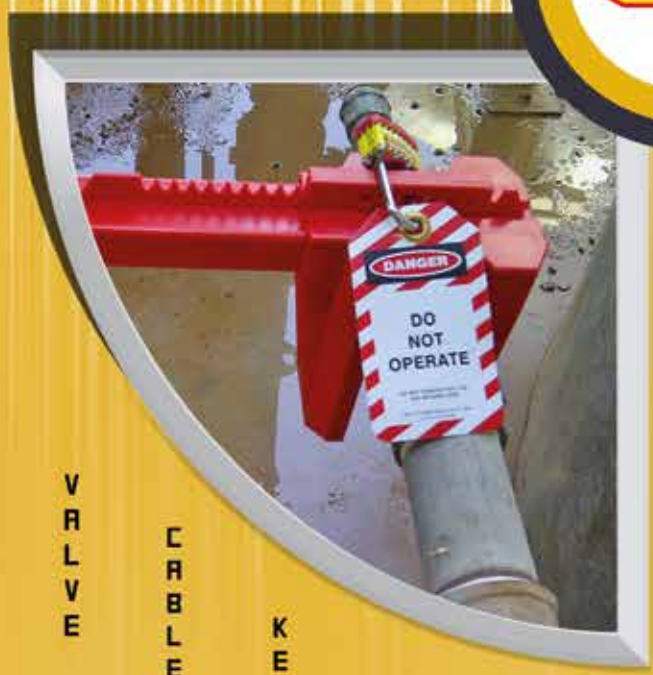

M E C H A N I C A L L O C K O U T S

V A L V E L O C K O U T S

C A B L E L O C K O U T S

K E Y C A B I N E T S

H A S P S

L O T O B A G S

L O T O S T A T I O N S

G R O U P L O C K O U T S

E L E C T R I C A L L O C K O U T S

HASPS

Model No.:	HSP-PMH-25R
Description:	Hasp - Steel, PE Injection Molded
	Handles, accommodates 6 Padlocks.
	Size: Small, Color: Red.
Size: 25 mm.	Dimensions:
Brand: LOTO-LOK®	Origin: China
Weight:	Packaging: 01 No.



Model No.:	HSP-PMH-38R
Description:	Hasp - Steel, PE Injection Molded
	Handles, accommodates 6 Padlocks.
	Size: Large, Color: Red.
Size: 38 mm.	Dimensions:
Brand: LOTO-LOK®	Origin: China
Weight:	Packaging: 01 No.



Model No.:	HSP-PMH-25B
Description:	Hasp - Steel, PE Injection Molded
	Handles, accommodates 6 Padlocks.
	Size: Small, Color: Blue.
Size: 25 mm.	Dimensions:
Brand: LOTO-LOK®	Origin: China
Weight:	Packaging: 01 No.



Model No.:	HSP-PMH-38B
Description:	Hasp - Steel, PE Injection Molded
	Handles, accommodates 6 Padlocks.
	Size: Large, Color: Blue.
Size: 38 mm.	Dimensions:
Brand: LOTO-LOK®	Origin: China
Weight:	Packaging: 01 No.



Model No.:	HSP-PMH-25Y
Description:	Hasp - Steel, PE Injection Molded
	Handles, accommodates 6 Padlocks.
	Size: Small, Color: Yellow.
Size: 25 mm.	Dimensions:
Brand: LOTO-LOK®	Origin: China
Weight:	Packaging: 01 No.



Model No.:	HSP-PMH-38Y
Description:	Hasp - Steel, PE Injection Molded
	Handles, accommodates 6 Padlocks.
	Size: Large, Color: Yellow.
Size: 38 mm.	Dimensions:
Brand: LOTO-LOK®	Origin: China
Weight:	Packaging: 01 No.



Model No.:	HSP-STL25-R
Description:	Hasp - Steel, all metal construction for high temperature use. Accommodates 6 Padlocks. Color: Red.
	Size: Small - 25mm
	Dimensions:
Brand: LOTO-LOK®	Origin: China
Weight:	Packaging: 01 No.



Model No.:	HSP-TAB-25
Description:	Hasp - Steel, PE Injection Molded
	Handles with Double Locking Tabs.
	Size: Small, Color: Red.
Size: 25 mm.	Dimensions:
Brand: LOK-FORCE™	Origin: China
Weight:	Packaging: 01 No.



Model No.:	HSP-TAB-38
Description:	Hasp - Steel, PE Injection Molded
	Handles with Double Locking Tabs.
	Size: Large, Color: Red.
Size: 38 mm.	Dimensions:
Brand: LOK-FORCE™	Origin: China
Weight:	Packaging: 01 No.



HASPS

Model No.:	HSP-AL-25	
Description:	Hasp - Aluminum Round Rod Scissor	
	Hasp, Nylon Injection Molded Handles. Size: Small. Color: Red.	
Size: 25 mm.	Dimensions:	
Brand: LOTO-LOK®	Origin: China	
Weight:	Packaging: 01 No.	



Model No.:	HSP-AL-38	
Description:	Hasp - Aluminum Round Rod Scissor	
	Hasp, Nylon Injection Molded Handles. Size: Large. Color: Red.	
Size: 38 mm.	Dimensions:	
Brand: LOTO-LOK®	Origin: China	
Weight:	Packaging: 01 No.	



Model No.:	HSP-SS316-25	
Description:	Hasp - Solid SS 316 Grade, Rust, Weather & Spark proof Hasp.	
	Accommodates 6 Padlocks.	
Size:	Dimensions:	
Brand: LOTO-LOK®	Origin: China	
Weight:	Packaging: 01 No.	



Model No.:	HSP-ALDS-2538	
Description:	Hasp - Aluminum, Dual jaw size	
	25/38 mm, Accommodates 8 Locks.	
Size: 25 x 38 mm.	Dimensions:	
Brand:	Origin: China	
Weight:	Packaging: 01 No.	



Model No.:	HSP-RNH-33	
Description:	Hasp - Nylon, Non-Conductive,	
	3.0mm Shackle diameter. Accommodates 3 Padlocks. Color: Red.	
Shackle dia: 3.0mm .		
Brand: LOTO-LOK®	Origin: China	
Weight:	Packaging: 01 No.	



Model No.:	HSP-RNH-36	
Description:	Hasp - Nylon, Non-Conductive,	
	6.0mm Shackle diameter. Accommodates 3 Padlocks. Color: Red.	
Shackle dia: 6.0 mm.		
Brand: LOTO-LOK®	Origin: China	
Weight:	Packaging: 01 No.	



Model No.:	HSP-RNH-65	
Description:	Hasp - Nylon, Non-Conductive,	
	5.0mm Shackle diameter. Accommodates 6 Padlocks. Color: Red.	
Shackle dia: 5.0 mm.		
Brand: LOTO-LOK®	Origin: China	
Weight:	Packaging: 01 No.	



Model No.:	HSP-RNH-66	
Description:	Hasp - Nylon, Non-Conductive,	
	6.0mm Shackle diameter. Accommodates 6 Padlocks. Color: Red.	
Shackle dia: 6.0 mm.		
Brand: LOTO-LOK®	Origin: China	
Weight:	Packaging: 01 No.	



Model No.:	HSP-DEY3	
Description:	Hasp - Nylon, Di-Electric	
	3.0mm Shackle diameter. Accommodates 4 Padlocks. Color: Yellow / Red.	
Shackle dia: 3.0 mm.		
Brand: LOTO-LOK®	Origin: China	
Weight:	Packaging: 01 No.	



HASPS

Model No.:	HSP-DEY6
Description:	Hasp – Nylon, Di-Electric
	6.0mm Shackle diameter. Accommodates 4 Padlocks. Color: Yellow / Red.
Shackle dia: 6.0 mm.	
Brand: LOTO-LOK®	Origin: China
Weight:	Packaging: 01 No.
	

Model No.:	HSP-SBS
Description:	Hasp – Steel, SHORT Shackle, Butterfly Type, Accommodates 4 Padlocks.
Dimensions: H82 x W60 x 10mm Dia.	
Brand:	Origin: China
Weight:	Packaging: 01 No.
	

Model No.:	HSP-SBL
Description:	Hasp – Steel, LONG Shackle, Butterfly Type, Accommodates 8 Padlocks.
Dimensions: H168 x W60 x 10mm Dia.	
Brand:	Origin: China
Weight:	Packaging: 01 No.
	

Model No.:	HSP-ALR-6
Description:	Hasp – Aluminum Alloy. Accommodates 6 Padlocks. Color: Red.
Dimensions: W77 x L190 mm.	
Brand:	Origin: China
Weight:	Packaging: 01 No.
	

Model No.:	HSP-ALH-25Y
Description:	Hasp – Aluminium with coated non-conductive shackle. 6 locks capacity. Color: Yellow / Black.
Dimensions:	
Brand:	Origin: China
Weight:	Packaging: 01 No.
	

Model No.:	HSP-TS3-4L
Description:	Hasp – Nylon body with 3.5mm Steel shackle for small apertures. 4 Locks capacity. Color: Red.
Shackle dia: 3.5mm Dia.	
Brand: LOTO-LOK®	Origin: China
Weight:	Packaging: 01 No.
	

Model No.:	HSP-SCORP
Description:	Hasp – Steel, Dual jaw size 25/38mm, Accommodates 6 Locks. Color: Red.
Dimensions: Standard	
Brand:	Origin: China
Weight:	Packaging: 01 No.
	

Model No.:	HSP-MST-724
Description:	Hasp – Aluminium with Snap-On Clip. Accommodates 5 padlocks. Available in 6 color labels Red, Yellow, Green, Blue, Orange & Black.
Dimensions: 1-3/4in x 2-1/8in (44.5mm x 54mm)	
Jaw Clearance.	
Brand:	Origin: China
Weight:	Packaging: 01 No.
	

CABLE LOCKOUTS

Model No.:	CL-PM-2MB
Description:	Cable Lockout - Premier
	Multipurpose Lockout + Hasp function. Color: Red. Cable: Black.
Cable Size: Dia. 4.0mm x Length 1.80 Mtr.	
Brand: LOTO-LOK®	Origin: China
Weight:	Packaging: 01 No.
	

Model No.:	CL-SQCL-1.5MR
Description:	Cable Lockout - Economy Squeezer
	Multipurpose, Galv. steel cable PVC coated with brass end cap. Color: Red.
Cable Size: Dia. 3.8mm x Length 1.50 Mtr.	
Brand: LOTO-LOK®	Origin: China
Weight:	Packaging: 01 No.
<p>Metal cable with PVC coating - One type cable ONLY red color</p> 	

Model No.:	CL-SQALM-1.5MC
Description:	Cable Lockout - Aluminium body,
	SS 304 cable. Ideal for high heat and extreme temperatures. 8 padlock holes.
Color: Satin.	
Cable Size: Dia. 4.0mm x 1.5 mtrs length.	
Brand: LOTO-LOK®	Origin: China
Weight:	Packaging: 01 No.
	

Model No.:	CL-SQC-3225
Description:	Cable Lockout - Grip Type with NYLON
	cable for locking multiple isolators and panels. ABS & PC construction, accommodates 4 Padlocks. Cable Length: 2.5 Mtrs.
Cable Diameter: 3.2mm. Color: Red.	
Brand: LOQ-IT	Origin: China
Weight:	Packaging: 01 No.
	

Model No.:	CL-SQC-5025
Description:	Cable Lockout - Grip Type with STEEL
	PVC Coated Cable. ABS & PC construction accommodates 4 Padlocks. Color: Red.
Cable Length: 2.5 Mtrs. Cable Diameter: 5.0mm.	
Brand: LOQ-IT	Origin: China
Weight:	Packaging: 01 No.
	

Model No.:	CL-3F-4MC
Description:	Cable Lockout - Adjustable with
	Stainless Steel PVC coated cable with brass end cap. Color: Red.
Cable Size: Dia. 5/32" (4mm) x Length 0.9 Mtrs.	
Brand: LOQ-IT	Origin: China
Weight:	Packaging: 01 No.
	

Model No.:	CL-5F-4MC
Description:	Cable Lockout - Adjustable with
	Stainless Steel PVC coated cable with brass end cap. Color: Red.
Cable Size: Dia. 5/32" (4mm) x Length 1.5 Mtrs.	
Brand: LOQ-IT	Origin: China
Weight:	Packaging: 01 No.
	

Model No.:	CL-6F-4MC
Description:	Cable Lockout - Adjustable with
	Stainless Steel PVC coated cable with brass end cap. Color: Red.
Cable Size: Dia. 5/32" (4mm) x Length 1.8 Mtrs.	
Brand: LOQ-IT	Origin: China
Weight:	Packaging: 01 No.
	

Model No.:	CL-16F-4MC
Description:	Cable Lockout - Adjustable with
	Stainless Steel PVC coated cable with brass end cap. Color: Red.
Cable Size: Dia. 5/32" (4mm) x Length 5.0 Mtrs.	
Brand: LOQ-IT	Origin: China
Weight:	Packaging: 01 No.
	

CABLE LOCKOUTS

Model No.:	CL-6F-6MC
Description:	Cable Lockout - Adjustable with
	Stainless Steel PVC coated cable with brass end cap. Color: Red.
Cable Size: Dia. 1/4" (6mm) x Length 1.8 Mtrs.	
Brand: LOQ-IT	Origin: China
Weight:	Packaging: 01 No.
	

Model No.:	CL-FT-2MR
Description:	Cable Lockout - FISH type.
	PVC coated cable with brass end cap. Color: Red.
Cable Size: Dia. 5.0mm x Length 2.0 Mtrs.	
Brand:	Origin: China
Weight:	Packaging: 01 No.
	

Model No.:	CL-PSM-2MR
Description:	Cable Lockout - Premium Squeezer
	Multipurpose with Vinyl Coated Steel Cable. Color: Red.
Cable Size: Dia. 3.50mm x Length 2.0 Mtrs.	
Brand:	Origin: China
Weight:	Packaging: 01 No.
	

Model No.:	CL-UNI-3MC
Description:	Cable Lockout - GRIP-ON with
	spring cable locking mechanism. PVC coated with brass end cap.
Color: Red. Cable Size: Dia. 4.0mm x Length 1.6 Mtrs.	
Brand:	Origin: China
Weight:	Packaging: 01 No.
	

Model No.:	CL-FLX-6FB
Description:	Cable Lockout - HASP type
	Multipurpose applications. Black PVC coated cable with brass end cap.
Color: Red. Cable Size: Dia. 4.8mm x Length 1.8 Mtrs.	
Brand:	Origin: China
Weight:	Packaging: 01 No.
	

Model No.:	CL-UM-2MY
Description:	Cable Lockout - WHEEL type.
	PVC coated cable with brass end cap. Color: Yellow.
Cable Size: Dia. 4.0mm x Length 2.0 Mtrs.	
Brand:	Origin: China
Weight:	Packaging: 01 No.
	

KAB-O-LOK™ CABLE LOCKOUTS

Model No.:	CL-DEVR
Description:	Cable Lockout - Comprises Base +
	Tightening Wheel. Manufactured from heat resistant Nylon PA66 Color: Red.
Diameter 73mm x Height 37 mm.	
Brand: KAB-O-LOK™	Origin: China
Weight:	Packaging: 01 No.

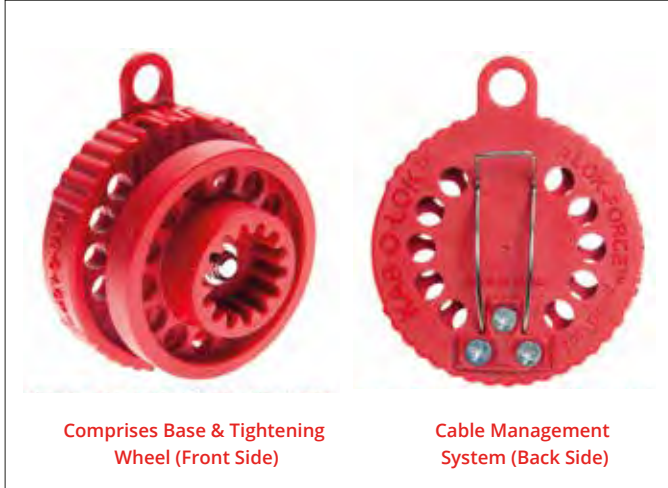

Model No.:	KABTOOL-R
Description:	KAB-TOOL Operating Tool for
	KAB-O-LOK™ Cable Lockout. Color: Red.
Diameter 76mm x Height 13 mm.	
Brand: KAB-O-LOK™	Origin: China
Weight:	Packaging: 01 No.

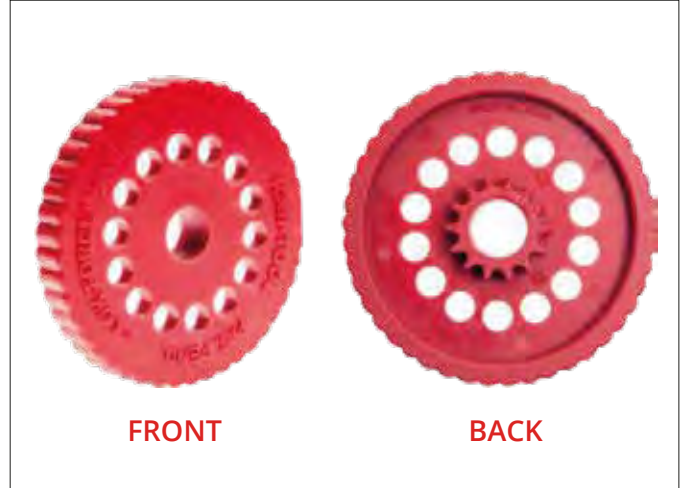

Watch how KAB-O-LOK's superior features and function can save \$\$\$\$ on reducing downtime compared to similar cable lockouts.

https://www.youtube.com/watch?v=qHf1_b6FHfs

(3D Animation of KAB-O-LOK function and features)

https://www.youtube.com/watch?v=-a_9Qpy4NzI

(Live demonstration of locking valves with KAB-O-LOK cable lockout)

COMPONENTS

Comprises Base & Tightening Wheel with Steel Galvanized PVC Coated Cable

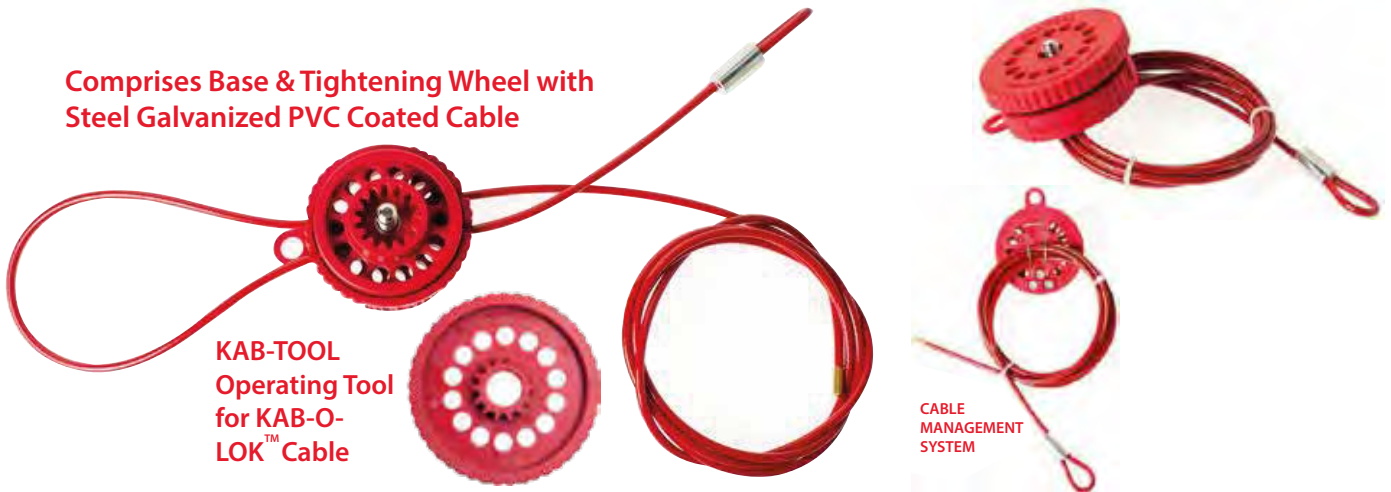

KAB-O-LOK™ CABLE LOCKOUTS

Model No.:	CL-DEVY
Description:	Cable Lockout - Comprises Base +
	Tightening Wheel. Manufactured from heat resistant Nylon PA66 Color: Yellow.
Diameter 73mm x Height 37 mm.	
Brand: KAB-O-LOK™	Origin: China
Weight:	Packaging: 01 No.



Comprises Base & Tightening Wheel (Front Side)

Cable Management System (Back Side)

Model No.:	KABTOOL-Y
Description:	KAB-TOOL Operating Tool for
	KAB-O-LOK™ Cable Lockout. Color: Yellow.
Diameter 76mm x Height 13 mm.	
Brand: KAB-O-LOK™	Origin: China
Weight:	Packaging: 01 No.

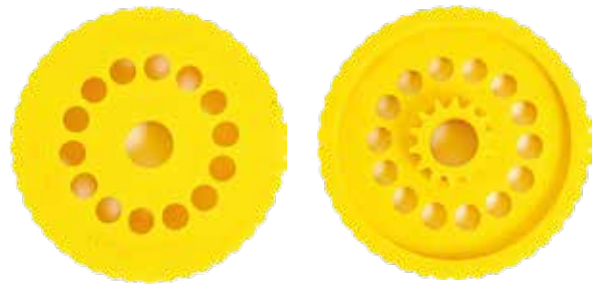

FRONT

BACK

Model No.:	CL-DEVG
Description:	Cable Lockout - Comprises Base +
	Tightening Wheel. Manufactured from heat resistant Nylon PA66 Color: Green.
Diameter 73mm x Height 37 mm.	
Brand: KAB-O-LOK™	Origin: China
Weight:	Packaging: 01 No.



Comprises Base & Tightening Wheel (Front Side)

Cable Management System (Back Side)

Model No.:	KABTOOL-G
Description:	KAB-TOOL Operating Tool for
	KAB-O-LOK™ Cable Lockout. Color: Green.
Diameter 76mm x Height 13 mm.	
Brand: KAB-O-LOK™	Origin: China
Weight:	Packaging: 01 No.



FRONT

BACK

PVC COATED CABLES FOR KAB-O-LOK™

Model No.:	CL-CAB2R
Description:	Cable - Steel Galvanised PVC coated with Aluminium eye at one end and crimped brass cap at other end. Color: Red.
Dimensions: I.D. 2.5mm x O.D. 3.8mm x L 2.0 Mtrs.	
Brand: KAB-O-LOK™	Origin: China
Weight:	Packaging: 01 No.
	

Model No.:	CL-CAB5R
Description:	Cable - Steel Galvanised PVC coated with Aluminium eye at one end and crimped brass cap at other end. Color: Red.
Dimensions: I.D. 2.5mm x O.D. 3.8mm x L 5.0 Mtrs.	
Brand: KAB-O-LOK™	Origin: China
Weight:	Packaging: 01 No.
	

Model No.:	CL-CAB10R
Description:	Cable - Steel Galvanised PVC coated with Aluminium eye at one end and crimped brass cap at other end. Color: Red.
Dimensions: I.D. 2.5mm x O.D. 3.8mm x L 10.0 Mtrs.	
Brand: KAB-O-LOK™	Origin: China
Weight:	Packaging: 01 No.
	

Model No.:	CL-CAB2Y
Description:	Cable - Steel Galvanised PVC coated with Aluminium eye at one end and crimped brass cap at other end. Color: Yellow.
Dimensions: I.D. 2.5mm x O.D. 3.8mm x L 2.0 Mtrs.	
Brand: KAB-O-LOK™	Origin: China
Weight:	Packaging: 01 No.
	

Model No.:	CL-CAB5Y
Description:	Cable - Steel Galvanised PVC coated with Aluminium eye at one end and crimped brass cap at other end. Color: Yellow.
Dimensions: I.D. 2.5mm x O.D. 3.8mm x L 5.0 Mtrs.	
Brand: KAB-O-LOK™	Origin: China
Weight:	Packaging: 01 No.
	

Model No.:	CL-CAB10Y
Description:	Cable - Steel Galvanised PVC coated with Aluminium eye at one end and crimped brass cap at other end. Color: Yellow.
Dimensions: I.D. 2.5mm x O.D. 3.8mm x L 10.0 Mtrs.	
Brand: KAB-O-LOK™	Origin: China
Weight:	Packaging: 01 No.
	

Model No.:	CL-CAB2G
Description:	Cable - Steel Galvanised PVC coated with Aluminium eye at one end and crimped brass cap at other end. Color: Green.
Dimensions: I.D. 2.5mm x O.D. 3.8mm x L 2.0 Mtrs.	
Brand: KAB-O-LOK™	Origin: China
Weight:	Packaging: 01 No.
	

Model No.:	CL-CAB5G
Description:	Cable - Steel Galvanised PVC coated with Aluminium eye at one end and crimped brass cap at other end. Color: Green.
Dimensions: I.D. 2.5mm x O.D. 3.8mm x L 5.0 Mtrs.	
Brand: KAB-O-LOK™	Origin: China
Weight:	Packaging: 01 No.
	

Model No.:	CL-CAB10G
Description:	Cable - Steel Galvanised PVC coated with Aluminium eye at one end and crimped brass cap at other end. Color: Green.
Dimensions: I.D. 2.5mm x O.D. 3.8mm x L 10.0 Mtrs.	
Brand: KAB-O-LOK™	Origin: China
Weight:	Packaging: 01 No.
	

KAB-O-LOK™ ACCESSORIES

Model No.:	CL-SPL-RD50M
Description:	CABLE SPOOL - Steel Galvanised
	PVC coated Cable. Color: Red.
	Cable Length: 50.0 Mtrs.
Size: (I.D. 2.5mm x O.D. 3.8mm)	
Brand: KAB-O-LOK™	Origin: China
Weight:	Packaging:

Spool of 50 Mtrs. Per Roll.



Model No.:	CL-SPL-GN50M
Description:	CABLE SPOOL - Steel Galvanised
	PVC coated Cable. Color: Green.
	Cable Length: 50.0 Mtrs.
Size: (I.D. 2.5mm x O.D. 3.8mm)	
Brand: KAB-O-LOK™	Origin: China
Weight:	Packaging:

Spool of 50 Mtrs. Per Roll.



Model No.:	CL-SPL-YL50M
Description:	CABLE SPOOL - Steel Galvanised
	PVC coated Cable. Color: Yellow.
	Cable Length: 50.0 Mtrs.
Size: (I.D. 2.5mm x O.D. 3.8mm)	
Brand: KAB-O-LOK™	Origin: China
Weight:	Packaging:

Spool of 50 Mtrs. Per Roll.



Model No.:	FRL-AL
Description:	Ferrule, Aluminium for crimping
	bare / coated cables up to
	3.8mm dia.
Brand:	Origin: China
Weight:	Packaging:

Pack of 50 Pcs.



WHEEL VALVE LOCKOUTS

Model No.:	VL-PGT-2563
Description:	Valve Lockout - PREMIER.
	Locks Wheel Valves dia. between 25 - 63 mm. Color: Red.
Size: 25 - 63 mm.	
Brand: LOTO-LOK®	Origin: China
Weight:	Packaging:
	

Model No.:	VL-PGT-63125
Description:	Valve Lockout - PREMIER.
	Locks Wheel Valves dia. between 63 - 125 mm. Color: Red.
Size: 63 - 125 mm.	
Brand: LOTO-LOK®	Origin: China
Weight:	Packaging:
	

Model No.:	VL-PGT-125165
Description:	Valve Lockout - PREMIER.
	Locks Wheel Valves dia. between 125 - 165 mm. Color: Red.
Size: 125 - 165 mm.	
Brand: LOTO-LOK®	Origin: China
Weight:	Packaging:
	

Model No.:	VL-PGT-165250
Description:	Valve Lockout - PREMIER.
	Locks Wheel Valves dia. between 165 - 250 mm. Color: Red.
Size: 165 - 250 mm.	
Brand: LOTO-LOK®	Origin: China
Weight:	Packaging:
	

Model No.:	VL-PGT-250325
Description:	Valve Lockout - PREMIER.
	Locks Wheel Valves dia. between 250 - 325 mm. Color: Red.
Size: 250 - 325 mm.	
Brand: LOTO-LOK®	Origin: China
Weight:	Packaging:
	

Model No.:	VL-PGT-330450
Description:	Valve Lockout - PREMIER.
	Locks Wheel Valves dia. between 330 - 450 mm. Color: Red.
Size: 330 - 450 mm.	
Brand: LOTO-LOK®	Origin: China
Weight:	Packaging:
	

Model No.:	VL-PGT-25325
Description:	Valve Lockout - PREMIER.
	Locks Wheel Valves dia. between 25 - 325 mm. Color: Red.
(Set of 5 Pcs. Consisting of 25mm to 325mm)	
Size: 25 - 325 mm.	
Brand: LOTO-LOK®	Origin: China
Weight:	Packaging:
	

Model No.:	VL-PGT-25450
Description:	Valve Lockout - PREMIER.
	Locks Wheel Valves dia. between 25 - 450 mm. Color: Red.
(Set of 6 Pcs. Consisting of 25mm to 450mm)	
Size: 25 - 450 mm.	
Brand: LOTO-LOK®	Origin: China
Weight:	Packaging:
	

Model No.:	VL-GVLA-25125
Description:	Adjustable Gate Valve Lockout.
	Locks Valve Wheel Diameters between 25 - 125 mm.
Size: 25 - 125 mm.	
Brand: LOTO-LOK®	Origin: China
Weight:	Packaging:
	

WHEEL VALVE LOCKOUTS

Model No.:	VL-MST-F480
Description:	Valve Lockout - ROTATING.
	Locks Valve Wheel Dia. between 25 - 76 mm.
Size: 25 - 76 mm.	
Brand:	Origin: China
Weight:	Packaging:
	

Model No.:	VL-MST-F481
Description:	Valve Lockout - ROTATING.
	Locks Valve Wheel Dia. between 50 - 127 mm.
Size: 50 - 127 mm.	
Brand:	Origin: China
Weight:	Packaging:
	

Model No.:	VL-MST-F482
Description:	Valve Lockout - ROTATING.
	Locks Valve Wheel Dia. between 101 - 165 mm.
Size: 101 - 165 mm.	
Brand:	Origin: China
Weight:	Packaging:
	

Model No.:	VL-MST-F483
Description:	Valve Lockout - ROTATING.
	Locks Valve Wheel Dia. between 152 - 254 mm.
Size: 152 - 254 mm.	
Brand:	Origin: China
Weight:	Packaging:
	

Model No.:	VL-MST-F484
Description:	Valve Lockout - ROTATING.
	Locks Valve Wheel Dia. between 203 - 330 mm.
Size: 203 - 330 mm.	
Brand:	Origin: China
Weight:	Packaging:
	

Model No.:	VL-MST-F485
Description:	Valve Lockout - ROTATING.
	Locks Valve Wheel Dia. between 25 - 330 mm.
Size: 25 - 330 mm.	
Brand:	Origin: China
Weight:	Packaging:
	

BALL VALVE LOCKOUTS

Model No.:	VL-BV-1032TL
Description:	Valve Lockout - BALL (Lever type).
	Locks Valve Sizes: 10 - 32 mm.
	Polypropylene construction. Color: Red.
Size: 10 - 32 mm.	
Brand:	Origin: China
Weight:	Packaging:
	

Model No.:	VL-BV-1364TL
Description:	Valve Lockout - BALL (Lever type).
	Locks Valve Sizes: 13 - 64 mm.
	Polypropylene construction. Color: Red.
Size: 13 - 64 mm.	
Brand:	Origin: China
Weight:	Packaging:
	

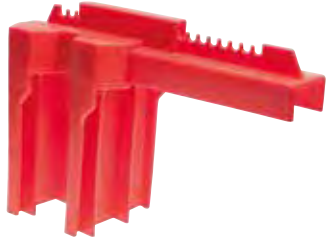
Model No.:	VL-BV-50200TL
Description:	Valve Lockout - BALL (Lever type).
	Locks Valve Sizes: 50 - 200 mm.
	Polypropylene construction. Color: Red.
Size: 50 - 200 mm.	
Brand:	Origin: China
Weight:	Packaging:
	

Model No.:	VL-BV-625STL
Description:	Valve Lockout - BALL
	(Steel Powder coated.) Color: Red.
	Locks Valve Sizes: 6 - 25 mm.
Size: 6 - 25 mm.	
Brand:	Origin: China
Weight:	Packaging:
	

Model No.:	VL-BV-3276STL
Description:	Valve Lockout - BALL
	(Steel Powder coated.) Color: Red.
	Locks Valve Sizes: 32 - 76 mm.
Size: 32 - 76 mm.	
Brand:	Origin: China
Weight:	Packaging:
	

Model No.:	VL-BV-625PVC
Description:	Valve Lockout - BALL
	(Steel Powder coated.) Color: Red.
	Two Piece PVC.
Size: 6 - 25 mm.	
Brand:	Origin: China
Weight:	Packaging:
	

Model No.:	VL-BV-HNDL
Description:	Valve Lockout - BALL Type, Seal Tight
	Handle-Off bag. Color: Red.
Bag Size: 324mm x 292 mm. Lock Diameter: 8mm	
Brand:	Origin: China
Weight:	Packaging: 01 No.
	

VALVE LOCKOUTS

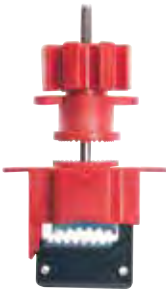
Model No.:	VL-UNAC41-1
Description:	Valve Lockout - UNIVERSAL
	Base Only. Fits upto 40mm width, 19mm thk. handles.
Locks Lever size: Width 40mm x Thk. 19 mm.	
Brand: LOQ-IT	Origin: China
Weight:	Packaging:
	

Model No.:	VL-UNAC41-2
Description:	Valve Lockout - UNIVERSAL
	Base + 2.0 mtrs. cable. Fits upto 40mm width, 19mm thk. handles.
Locks Lever size: Width 40mm x Thk. 19 mm.	
Brand: LOQ-IT	Origin: China
Weight:	Packaging:
	

Model No.:	VL-UNAC41-3
Description:	Valve Lockout - UNIVERSAL
	Base + 1 Arm. Fits upto 40mm width, 19mm thk. handles.
Locks Lever size: Width 40mm x Thk. 19 mm.	
Brand: LOQ-IT	Origin: China
Weight:	Packaging:
	

Model No.:	VL-UNAC41-4
Description:	Valve Lockout - UNIVERSAL
	Base + Cable + 1 Arm. Fits upto 40mm width, 19mm thk. handles
Locks Lever size: Width 40mm x Thk. 19 mm.	
Brand: LOQ-IT	Origin: China
Weight:	Packaging:
	

Model No.:	VL-UNAC41-5
Description:	Valve Lockout - UNIVERSAL
	Base + 2 Arms. Fits upto 40mm width, 19mm thk. handles.
Locks Lever size: Width 40mm x Thk. 19 mm.	
Brand: LOQ-IT	Origin: China
Weight:	Packaging:
	

Model No.:	VL-UNAC41-6
Description:	Valve Lockout - UNIVERSAL
	Base + Cable + 2 Arms. Fits upto 40mm width, 19mm thk. handles.
Locks Lever size: Width 40mm x Thk. 19 mm.	
Brand: LOQ-IT	Origin: China
Weight:	Packaging:
	

Model No.:	VL-41-ARM
Description:	Blocking Arm for Universal Valve Lockout.
	Polypropylene materials, Color: Red.
Size:	Dimensions:
Brand:	Origin: China
Weight:	Packaging:
	

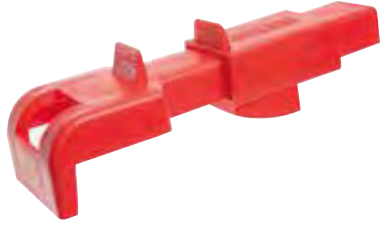
Model No.:	VL-BF-LEV
Description:	Valve Lockout - Butterfly
	construction, Locks Spring type Lever handle butterfly valves. Color: Red.
Size: Standard	Dimensions:
Brand: LOTO-LOK®	Origin: China
Weight:	Packaging:
	

Model No.:	VL-BF-SAN
Description:	Valve Lockout - Sanitary Butterfly
	Suitable for locking round handle sanitary valves. Locks 5mm - 25mm handle dia.
Size: 5 - 25 mm.	Dimensions:
Brand:	Origin: China
Weight:	Packaging:
	

BUTTERFLY & PLUG VALVE LOCKOUTS

Model No.:	VL-PVLO
Description:	Valve Lockout - Plug
	Locking range: 10~34mm rectangular valve stem; 15~50mm round valve stem.
Size:	
Brand:	Origin: China
Weight:	Packaging:
	

Model No.:	VL-BF-2P
Description:	Valve Lockout - Butterfly Valve
	Lockout Device + Cable Lockout.
	Suitable for locking out Spring type
Lever handle 0.8~4.5cm butterfly valves. Size: 0.8~4.5cm.	
Brand:	Origin: China
Weight:	Packaging:
	

Model No.:	VL-BF-1P
Description:	Valve Lockout - Butterfly Valve
	Lockout Device Only (without Cable Lockout).
	Suitable for locking out Spring type
Lever handle 0.8~4.5cm butterfly valves. Size: 0.8~4.5cm.	
Brand:	Origin: China
Weight:	Packaging:
	

FLANGE LOCKOUTS

Model No.:	FL-SM-1319
Description:	Flange Lockout - Aluminium alloy & hardened steel, suitable for blocking nuts on blind flanges, prevents unauthorized flange removal. Color: Red.
Size:	Locks nuts between 13 - 19mm
Brand: LOQ-IT	Origin: China
Weight:	Packaging: 01 No.
	

Model No.:	FL-MD-2332
Description:	Flange Lockout - Aluminium alloy & hardened steel, suitable for blocking nuts on blind flanges, prevents unauthorized flange removal. Color: Red.
Size:	Locks nuts between 23 - 32mm
Brand: LOQ-IT	Origin: China
Weight:	Packaging: 01 No.
	

Model No.:	FL-LG-3548
Description:	Flange Lockout - Aluminium alloy & hardened steel, suitable for blocking nuts on blind flanges, prevents unauthorized flange removal. Color: Red.
Size:	Locks nuts between 35 - 48mm
Brand: LOQ-IT	Origin: China
Weight:	Packaging: 01 No.
	

CIRCUIT BREAKER LOCKOUTS (MCB & MCCB)

Model No.:	CB-PI-CTBL
Description:	Circuit Breaker Locking Device
	PIN-IN for Single Pole MCB's.
	Color: Green.
Brand: LOTO-LOK®	Origin: China
Weight:	Packaging:



Model No.:	CB-PO-CTBL
Description:	Circuit Breaker Locking Device
	PIN-OUT for Single & Multipole MCB's.
	Color: Yellow.
Brand: LOTO-LOK®	Origin: China
Weight:	Packaging:



Model No.:	CB-POW-CTBL
Description:	Circuit Breaker Locking Device
	PIN-OUT- WIDE for Single & Multipole MCB's.
	Color: Blue
Brand: LOTO-LOK®	Origin: China
Weight:	Packaging:



Model No.:	CB-COMBO-CTBL
Description:	Circuit Breaker Locking Device - Pin Combo (SET OF 3) for Miniature Circuit Breaker. 1 off PIN - IN, 1 off PIN - OUT, & 1 off PIN - OUT - WIDE.
Brand: LOTO-LOK®	Origin: China
Weight:	Packaging:



Model No.:	CB-MG-CTBL
Description:	Circuit Breaker Locking Device - for Single & Multi Pole MCB's & MCCB's. Opened & closed with Screwdriver. Color: Yellow.
Brand: LOTO-LOK®	Origin: China
Weight:	Packaging:



Model No.:	CB-POL-Y
Description:	Circuit Breaker Locking Device
	PIN-OUT for Single & Multipole MCB's with LATCH. Color: Yellow
Brand: LOTO-LOK®	Origin: China
Weight:	Packaging:



Model No.:	CB-AB-CTBL
Description:	Circuit Breaker Locking Device - for Single & Multi Pole MCB's & MCCB's. Opened & closed with Screwdriver. Color: Blue.
Brand: LOTO-LOK®	Origin: China
Weight:	Packaging:



Model No.:	CB-FLRD
Description:	Circuit Breaker / Fuse lockout
	Screwdriver Required, Color: Red.
Brand:	Origin: China
Weight:	Packaging:



Model No.:	CB-UB-CTBL
Description:	Circuit Breaker Locking Device
	for Single Pole MCB's. Opened & closed with screwdriver. Color - Red.
Brand: LOTO-LOK®	Origin: China
Weight:	Packaging:



CIRCUIT BREAKER LOCKOUTS (MCB & MCCB)

Model No.:	CB-UNI-HT
Description:	Circuit Breaker Locking Device,
	Universal type for Single & Multipole
	MCB's & MCCB's upto 200A.
	Hand Tightening. NO-TOOL. Color: Red.
Brand: LOQ-IT	Origin: China
Weight:	Packaging:



Model No.:	CB-UNI-DTHT
Description:	Circuit Breaker Locking Device
	Universal type with Dove Tail for locking
	a wide range of MCCB's up to 200 Amps.
	Hand Tightening. NO-TOOL. Color: Red.
Brand: LOQ-IT	Origin: China
Weight:	Packaging:



Model No.:	CB-COV94
Description:	Circuit Breaker Locking Device - Universal
	type for Single & Multipole MCB's &
	MCCB's upto 200A with cover and 2 way
	padlocking slots. NO-TOOL. Color: Red.
Brand:	Origin: China
Weight:	Packaging:



Model No.:	CB-UNIHT-4ST
Description:	Circuit Breaker Locking Device
	Universal type for Multipole MCB & MCCB,
	Hand Tightening. NO-TOOL. Color: Red.
Brand: LOQ-IT	Origin: China
Weight:	Packaging:



Model No.:	CB-UNIDTHT-4ST
Description:	Circuit Breaker Locking Device
	Universal type for MCCB's. Hand
	Tightening. NO-TOOL. Color: Red.
Brand: LOQ-IT	Origin: China
Weight:	Packaging:



Model No.:	STL-CTBL
Description:	Circuit Breaker Locking Device -
	for Schneider MCCB's with multiple
	padlocking facility. Steel construction.
Brand:	Origin: China
Weight:	Packaging:



Model No.:	CB-TB
Description:	Circuit Breaker Locking Device -
	Tie Bar for Multi Pole MCB's.
	Color - Red.
Brand: LOTO-LOK®	Origin: China
Weight:	Packaging:



Model No.:	CB-UMPBL
Description:	Circuit Breaker Locking Device -
	Universal Multi Pole Circuit Breaker
	Lockout. Color: Red.
Brand: LOTO-LOK®	Origin: China
Weight:	Packaging:



Model No.:	CB-CLO
Description:	Circuit Breaker Locking Device
	Clamp on, Pin type for MCCB toggles
	with holes. Color: Red.
Brand: LOTO-LOK®	Origin: China
Weight:	Packaging:



CIRCUIT BREAKER LOCKOUTS (MCB & MCCB)

Model No.:	LSP - COMBO - 5SET
Description:	Circuit Breaker Locking Device
	Combo Circuit Breaker Lockout. Set of 5 Pcs.
Brand: LOTO-LOK®	Origin: China
Weight:	Packaging:



Model No.:	CB-BT-CTBL
Description:	Circuit Breaker Locking Device
	for MCCB's with Large Toggles upto 600 AMPS. Color: Red.
Brand: LOTO-LOK®	Origin: China
Weight:	Packaging:



Model No.:	CB-DUO-CTBL
Description:	Circuit Breaker Locking Device
	for MCB's & MCCB's. Accomodates different toggle sizes. Color: Red
Brand:	Origin: China
Weight:	Packaging:



Model No.:	CB-KT-S
Description:	Circuit Breaker Locking Device
	locks outs 277 Volts MCCB's with toggle widths 16mm x Thk. 11.5 mm.
Thumbwheel operation. Color: Red. Size: Small.	
Brand: LOQ-IT	Origin: China
Weight:	Packaging:



Model No.:	CB-KT-M
Description:	Circuit Breaker Locking Device
	locks outs 480/600Volts MCCB's with toggle widths 41mm x Thk. 13.5 mm.
Thumbwheel operation. Color: Red. Size: Medium.	
Brand: LOQ-IT	Origin: China
Weight:	Packaging:



Model No.:	CB-KT-L
Description:	Circuit Breaker Locking Device
	locks outs 480/600Volts MCCB's with Oversized toggle widths
	63mm x Thk. 22 mm. Thumbwheel operation. Color: Red. Size: Large.
Brand: LOQ-IT	Origin: China
Weight:	Packaging:



Model No.:	CB-LCB-RH
Description:	Circuit Breaker Locking Device -
	for MCCB with large toggles upto 600Amps. Round handle. NO-TOOL required. Accommodates multiple padlocks.
Brand:	Origin: China
Weight:	Packaging:



Model No.:	CB-LCB-HT
Description:	Circuit Breaker Locking Device - for MCCB
	with large toggles upto 600Amps. NO-TOOL required. Tightens by hand.
Brand:	Origin: China
Weight:	Packaging:





Model No.:	CB-MCB-S
Description:	Circuit Breaker Locking Device to lock
	MCCB upto 49 mm body length. Nylon body with aluminium jaws.
Ideal for blocking MCB's. Color: Red	
Dimensions: Inner Lgth 49mm x Inner Width 30mm	
Brand: LOTO-LOK®	Origin: China
Weight:	Packaging: 01 No.

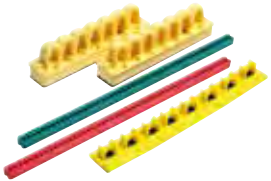

CIRCUIT BREAKER LOCKOUTS (MCB & MCCB)

Model No.:	CB-MCB
Description:	Circuit Breaker Locking Device to lock MCB upto 61 mm body length.
	Nylon body with aluminium jaws.
Ideal for blocking MCB's. Color: Red	
Dimensions: Inner Lgth 61mm x Inner Width 40mm	
Brand: LOTO-LOK®	Origin: China
Weight:	Packaging: 01 No.
	

Model No.:	CB-BBK-5
Description:	Circuit Breaker Locking Device locks out 600A MCCB's with Oversized toggles. (Break Blocker Components)
	480v~600v. Set consists of 2 self adhesive bases, 1 Red & 1 Green blocking bars and 1 self adhesive bar holder.
Brand:	Origin: China
Weight:	Packaging:
	

Model No.:	CB-MST-4093
Description:	Circuit Breaker Locking Device for MCCB's with small toggles.
	Color: Red. Size: Small.
Brand:	Origin: China
Weight:	Packaging:
	

Model No.:	CB-MST-4091
Description:	Circuit Breaker Locking Device for MCCB's with tall and wider Toggles.
	Color: Red. Size: Large.
Brand:	Origin: China
Weight:	Packaging:
	

Model No.:	CB-SCNH-PO
Description:	Circuit Breaker Locking Device for PIN type single & multipole MCB's.
	Material: Nylon PA. Color: Yellow.
Brand:	Origin: China
Weight:	Packaging:
	

Model No.:	CB-DP-CTBL
Description:	Circuit Breaker Locking Device Locks 2 pole MCB's.
	Color: Red.
Brand:	Origin: China
Weight:	Packaging:
	

Model No.:	CB-SP-CTBL
Description:	Circuit Breaker Locking Device Locks Single Pole MCB's.
	Color: Red.
Brand:	Origin: China
Weight:	Packaging:
	

Model No.:	CB-MP-CTBL
Description:	Circuit Breaker Locking Device Locks Single Pole MCB's.
	Color: Red.
Brand:	Origin: China
Weight:	Packaging:
	

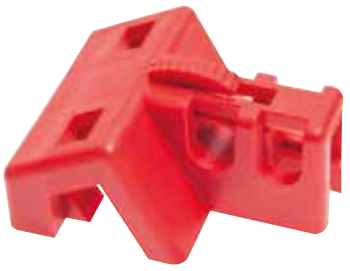
Model No.:	CB-TG-CTBL
Description:	Circuit Breaker Locking Device Locks 2 pole MCB's.
	Color: Red.
Brand:	Origin: China
Weight:	Packaging:
	

PANEL & PUSH BUTTON LOCKOUTS

Model No.:	PL-CIR-45
Description:	Panel Lockout - Push Button
	Polycarbonate material. Transparent.
	Circular Base 45mm Diameter.
Size: 45mm Dia.	Dimensions:
Brand: LOTO-LOK®	Origin: China
Weight:	Packaging:

Base permanently mounts on Panel with double sided tape.



Model No.:	PL-CIR-55
Description:	Panel Lockout - Push Button
	Polycarbonate material. Transparent.
	Circular Base 55mm Diameter.
Size: 55mm Dia.	Dimensions:
Brand: LOTO-LOK®	Origin: China
Weight:	Packaging:

Base permanently mounts on Panel with double sided tape.



Model No.:	PL-SQS-50
Description:	Panel Lockout - Push Button / Switch
	Polycarbonate material. Transparent.
	Inner Size: 58 x 58 mm.
Size: 58 x 58mm	Dimensions:
Brand: LOTO-LOK®	Origin: China
Weight:	Packaging:

Base permanently mounts on Panel with double sided tape.



Model No.:	PL-SQB-75
Description:	Panel Lockout - Push Button / Switch
	Polycarbonate material. Transparent.
	Inner Size: 58mm Height x 75mm Width.
Size: H 58 x W 75 mm.	Dimensions:
Brand: LOTO-LOK®	Origin: China
Weight:	Packaging:

Base permanently mounts on Panel with double sided tape.



Model No.:	PL-SQB-90
Description:	Panel Lockout - Push Button / Switch
	Acrylic material. Transparent.
Inner Size: 80mm Length x 80mm Width x 58mm Depth.	
Brand: LOTO-LOK®	Origin: India
Weight:	Packaging: 01 No.

Base permanently mounts on Panel with double sided tape.



Model No.:	PL-EPB-90
Description:	Panel Lockout - Push Button Emergency
	Polycarbonate material. Transparent.
	30mm I.D. Base X 70mm Internal I.D.
Size: 30 x 70mm	Dimensions:
Brand: LOTO-LOK®	Origin: China
Weight:	Packaging:

Removable Device. Non-permanent.



Model No.:	PL-BT-22
Description:	Panel Lockout - Push Button
	Polycarbonate material. Transparent.
	Accommodates upto 22mm dia Base.
Size: 22mm I.D.	Dimensions:
Brand: LOTO-LOK®	Origin: China
Weight:	Packaging:

Device mounts permanently on Base of Push Button.



Model No.:	PL-BT-30
Description:	Panel Lockout - Push Button
	Polycarbonate material. Transparent.
	Accommodates upto 30mm dia Buttons.
Size: 30mm I.D.	Dimensions:
Brand: LOTO-LOK®	Origin: China
Weight:	Packaging:

Device mounts permanently on Base of Push Button.



Model No.:	PL-CB-22E53
Description:	Panel Lockout - Push Button
	Polycarbonate material. Transparent.
	Accommodates 22mm dia Buttons.
Size: 22 mm.	Dimensions:
Brand:	Origin: China
Weight:	Packaging:

Collar mounts permanently on Base of Push Button - Cover is removable.



PANEL & PUSH BUTTON LOCKOUTS

Model No.:	PL-CB-30E53
Description:	Panel Lockout - Push Button
	Polycarbonate material. Transparent.
	Accommodates 30mm dia Buttons.
Size: 30 mm.	Dimensions:
Brand:	Origin: China
Weight:	Packaging:

Collar mounts permanently on Base of Push Button - Cover is removable.



Model No.:	PL-RC-22
Description:	Panel Lockout - Push Button
	Polycarbonate material. Clear/Red.
	Accommodates 22mm dia Buttons.
Size: 22 mm.	Dimensions:
Brand:	Origin: China
Weight:	Packaging:

Device mounts permanently on Base of Push Button.



Model No.:	PL-RC-30
Description:	Panel Lockout - Push Button
	Polycarbonate material. Clear/Red.
	Accommodates 30mm dia Buttons.
Size: 30 mm.	Dimensions:
Brand:	Origin: China
Weight:	Packaging:

Device mounts permanently on Base of Push Button.



Model No.:	PL-AD-2732
Description:	Panel Lockout - Push Button Adjustable
	Fits 27~32mm diameter push buttons and round switch knobs.
Size: 62 x 54mm Dia.	Dimensions:
Brand:	Origin: China
Weight:	Packaging:

Removable Device. Non-permanent. Ideal for locking push buttons where the base cannot be removed.



FUSE LOCKOUTS

Model No.:	FL-BR-FW
Description:	Fuse Lockout - Four Way.
	Fits fuses 1/4", 9/32", 13/32" & 9/16" in size. Color: Red.
Size:	
Brand:	Origin: China
Weight:	Packaging:
	

Model No.:	FL-BR-TW
Description:	Fuse Lockout - Two Way
	Fits fuses 13/16", 11/16" & blade type fuses. Color: Red.
Size:	
Brand:	Origin: China
Weight:	Packaging:
	

Model No.:	CB-FLRD
Description:	Circuit Breaker / Fuse lockout
	Screwdriver Required, Color: Red.
Size:	
Brand:	Origin: China
Weight:	Packaging:
	

WALL SWITCH LOCKOUTS

Model No.:	WSL-RD-MST
Description:	Wall Switch Lockout
	Color: Red.
Dimensions:	
Brand:	Origin: China
Weight:	Packaging:
	

Model No.:	WSL-443
Description:	Wall Switch Lockout
	Polycarbonate Lockable Single Switch Electrical Socket Covers.
Dimensions: 99.92 mm x 99.52 mm x 64.72 mm.	
Brand: LOTO-LOK®	Origin: China
Weight:	Packaging:
	

Model No.:	WSL-643
Description:	Wall Switch Lockout
	Polycarbonate Lockable Dual Switch Electrical Socket Covers.
Dimensions: 158.32 mm x 98.04 mm x 64.71 mm.	
Brand: LOTO-LOK®	Origin: China
Weight:	Packaging:
	

PNEUMATIC COUPLER LOCKOUTS

Model No.:	PNL-SS-612
Description:	Pneumatic Lockout - Stainless Steel
	Locks Male Connector sizes: 1/4", 3/8" & 1/2".
Dimensions: 1/4", 3/8" & 1/2".	
Brand:	Origin: China
Weight:	Packaging:



Model No.:	PNL-PLRD-612
Description:	Pneumatic Lockout - Nylon 3 Way.
	Locks Male Connector sizes: 1/4", 3/8" & 1/2". Color : Red.
Dimensions: 1/4", 3/8" & 1/2".	
Brand:	Origin: China
Weight:	Packaging:



CYLINDER, PLUG & PENDANT LOCKOUTS

Model No.:	PLG-RPL-Y
Description:	Plug Lockout - Electrical.
	Round, Color: Yellow
	Size: W 126 x L 160 x Ø 103mm.
Dimensions: 126 x 160 x Ø 103mm.	
Brand:	Origin: China
Weight:	Packaging:
	

Model No.:	PLG-RPL-R
Description:	Plug Lockout - Electrical.
	Round, Color: Red.
	Size: W 126 x L 160 x Ø 103mm.
Dimensions: 126 x 160 x Ø 103mm.	
Brand:	Origin: China
Weight:	Packaging:
	

Model No.:	PLG-LRPM
Description:	Plug Lockout - Electrical.
	Locks small & medium sized electrical plugs. Color: Red.
Dimensions: 65 x 65 x 118mm.	
Brand:	Origin: China
Weight:	Packaging:
	

Model No.:	PLG-LRPL
Description:	Plug Lockout - Electrical.
	Locks Large size electrical plugs.
	Color: Red.
Dimensions: 83 x 83 x 178mm.	
Brand:	Origin: China
Weight:	Packaging:
	

Model No.:	PLG-EP4H
Description:	Plug Lockout - Electrical / Pneumatic.
	Locks electrical plugs & pneumatic fittings. Color: Red.
Dimensions: 97 x 95 x 170mm.	
Brand:	Origin: China
Weight:	Packaging:
	

Model No.:	PLG-RND-SM
Description:	Plug Lockout - Rotating housing. Ideal for locking small electrical 2 or 3 pin plugs. Color: Red.
Dimensions: W 58 x H 95mm.	
Brand: LOTO-LOK®	Origin: China.
Weight:	Packaging: 01 No.
	

Model No.:	PLG-RND-LG
Description:	Plug Lockout - Rotating housing. Ideal for locking medium sized electrical sized plugs. Color: Red.
Dimensions: W 78 x H 169mm.	
Brand: LOTO-LOK®	Origin: China.
Weight:	Packaging: 01 No.
	

Model No.:	PNDT-9X9
Description:	Pendant & Plug Lockout.
	Color: Red. Size: Small.
	Lockouts Large Plugs & Small Pendants.
Dimensions: W9" x H9"	
Brand: LOTO-LOK®	Origin: India
Weight:	Packaging:
	

Model No.:	PNDT-9X12
Description:	Pendant & Plug Lockout.
	Color: Red. Size: Medium. Lockouts Extra Large Plugs & Small Pendants.
Dimensions: W9" x H12"	
Brand: LOTO-LOK®	Origin: India
Weight:	Packaging:
	

CYLINDER, PLUG & PENDANT LOCKOUTS

Model No.:	PNDT-9X18	
Description:	Pendant & Plug Lockout.	
	Color: Red. Size: Large.	
	Lockouts Medium Pendants.	
Dimensions:	W9" x H18"	
Brand: LOTO-LOK®	Origin: India	
Weight:	Packaging:	
		

Model No.:	PNDT-9X26	
Description:	Pendant & Plug Lockout.	
	Color: Red. Size: Extra Large.	
	Lockouts Large Pendants.	
Dimensions:	W9" x H26"	
Brand: LOTO-LOK®	Origin: India	
Weight:	Packaging:	
		

SPECIAL APPLICATION LOCKOUTS

Model No.:	MPD-YBPL-26
Description:	Switch Lockout Device – Panel Lockout with Adhesive Base. Color: Yellow.
	Locks knob switch & change over switch.
Size:	
Brand:	Origin: China
Weight:	Packaging:
Adhesive Base	
	

Model No.:	MPD-YBPL-27
Description:	Switch Lockout Device – Panel Lockout with Adhesive Base. Color: Yellow.
	Locks Push buttons & Covers Key Holes.
Size:	
Brand:	Origin: China
Weight:	Packaging:
Adhesive Base	
	

Model No.:	MPD-YBPL-28
Description:	Switch Lockout Device – Panel Lockout with Adhesive Base. Color: Yellow.
	Immobilises cabinet doors & Covers Key Holes.
Size:	
Brand:	Origin: China
Weight:	Packaging:
Adhesive Base	
	

Model No.:	MPD-YBPL-29
Description:	Switch Lockout Device – Panel Lockout with Adhesive Base. Color: Yellow.
	Lock switch handles & change over switch.
Size:	
Brand:	Origin: China
Weight:	Packaging:
Adhesive Base	
	

Model No.:	MPD-YBPL-30
Description:	Switch Lockout Device – Panel Lockout with Adhesive Base. Color: Yellow.
	Lock knife switches & Isolator handles.
Size:	
Brand:	Origin: China
Weight:	Packaging:
Adhesive Base	
	

CAR SEALS, TAGS & DISCS

Model No.:	CS-RED-1M
Description:	Car Seals - Aluminium / Zinc Body, Galvanized
	wire cable 1 mtr. Long, Self-Locking with Unique Serial No. printed on each piece. Color: Red.
Size: 2.5mm wire dia x 1mtr Length	
Brand: LOTO-LOK®	Origin: China
Weight:	Packaging:
	

Model No.:	CS-GRN-1M
Description:	Car Seals - Aluminium / Zinc Body, Galvanized
	Aircraft wire cable 1 mtr. Long, Self-Locking with Unique Serial No. printed on each piece. Color: Green.
Size: 2.5mm wire dia x 1mtr Length	
Brand: LOTO-LOK®	Origin: China
Weight:	Packaging:
	

Model No.:	CS-GRY-1M
Description:	Car Seals - Aluminium / Zinc Body, Galvanized
	Aircraft wire cable 1 mtr. Long, Self-Locking with Unique Serial No. printed on each piece. Color: Grey.
Size: 2.5mm wire dia x 1mtr Length	
Brand: LOTO-LOK®	Origin: China
Weight:	Packaging:
	

Model No.:	CS-BLU-1M
Description:	Car Seals - Aluminium / Zinc Body, Galvanized
	Aircraft wire cable 1 mtr. Long, Self-Locking with Unique Serial No. printed on each piece. Color: Blue.
Size: 2.5mm wire dia x 1mtr Length	
Brand: LOTO-LOK®	Origin: China
Weight:	Packaging:
	

Model No.:	CS-BLK-1M
Description:	Car Seals - Aluminium / Zinc Body, Galvanized Aircraft
	wire cable 1 mtr. Long, Self-Locking with Unique Serial No. printed on each piece. Color: Black.
Size: 2.5mm wire dia x 1mtr Length	
Brand: LOTO-LOK®	Origin: China
Weight:	Packaging:
	

Model No.:	CST-VLVC-R
Description:	Disc - "VALVE LOCKED CLOSED".
	Material: Stainless Steel 316. With 190 mm. Long stainless-steel wire. Color: Red
Size: 40mm Dia.	Thickness: 1 mm.
Brand:	Origin: China
Weight:	Packaging:
	

Model No.:	CST-VLVO-G
Description:	Disc - "VALVE LOCKED OPEN".
	Material: Stainless Steel 316. With 190 mm. Long stainless-steel wire. Color: Green.
Size: 40mm Dia.	Thickness: 1 mm.
Brand:	Origin: China
Weight:	Packaging:
	

Model No.:	TAGD-CSR
Description:	Tag - "CAR SEAL CLOSED". Color: Red.
	PVC Sheet with one side printing with Metal OR Punched Eyelet.
Size: W80mm x L160mm x Thk.0.5mm	
Brand:	Origin: China
Weight:	Packaging:
	

Model No.:	TAGD-CSG
Description:	Tag - "CAR SEAL OPEN". Color: Green.
	PVC Sheet with one side printing with Metal OR Punched Eyelet.
Size: W80mm x L160mm x Thk.0.5mm	
Brand:	Origin: China
Weight:	Packaging:
	

PIN & SLEEVE LOCKOUTS

Model No.:	PSL-S40
Description:	Pin & Sleeve Industrial socket lockout
	diameter 40mm, suitable for locking Small size sockets.
Size: 40mm dia.	
Brand:	Origin: China
Weight:	Packaging:
	

Model No.:	PSL-M44
Description:	Pin & Sleeve Industrial socket lockout
	diameter 44mm, suitable for locking Medium size sockets.
Size: 44mm dia.	
Brand:	Origin: China
Weight:	Packaging:
	

Model No.:	PSL-L50
Description:	Pin & Sleeve Industrial socket lockout
	diameter 50mm, suitable for locking Large size sockets.
Size: 50mm dia.	
Brand:	Origin: China
Weight:	Packaging:
	

Model No.:	PSL-XL63
Description:	Pin & Sleeve Industrial socket lockout
	diameter 63mm, suitable for locking Extra Large size sockets.
Size: 63mm dia.	
Brand:	Origin: China
Weight:	Packaging:
	

Model No.:	PSL-XL73
Description:	Pin & Sleeve Industrial socket lockout
	diameter 73mm, suitable for locking Extra Large size sockets.
Size: 73mm dia.	
Brand:	Origin: China
Weight:	Packaging:
	

LOTO STATIONS

Model No.:	LS-7L2P-Y
Description:	Lockout Station - Molded Plastic, durable & unbreakable. Configuration: 7 Hooks for Padlocks + 2 Tag Pockets (upto 10 Tags per pocket) + 2 Hooks (can store upto 2 Hasps per hook). Empty Station Only. Color: Yellow
Dimensions:	L300 x W400 mm.
Brand: LOTO-LOK®	Origin: China
Weight:	Packaging:
	

Model No.:	LS-7L2P-Y-CS
Description:	Lockout Station - Molded Plastic, durable & unbreakable. 7 Padlocks + 20 Tags + Cable Ties + Marker Pen + 2 Hasps. Complete Station with contents. Color: Yellow.
Dimensions:	L300 x W400 mm.
Brand: LOTO-LOK®	Origin: China
Weight:	Packaging:
	

Model No.:	LS-16L-1P-Y
Description:	Lockout Station - Molded Plastic, durable & unbreakable. Configuration: 16 Hooks for Padlocks + 1 Tag Pocket (upto 10 Tags) + 2 Hooks (can store upto 2 Hasps per hook). Empty Station Only. Color: Yellow.
Dimensions:	L350 x W360 mm.
Brand: LOTO-LOK®	Origin: China
Weight:	Packaging:
	

Model No.:	LS-16L-1P-Y-CS
Description:	Lockout Station - Molded Plastic, durable & unbreakable. 16 Padlocks + 10 Tags + Cable Ties + Marker Pen + 2 Hasps. Complete Station with contents. Color: Yellow.
Dimensions:	L350 x W360 mm.
Brand: LOTO-LOK®	Origin: China
Weight:	Packaging:
	

Model No.:	LS-ACST-24L2P-EB
Description:	Lockout Station - Heavy duty acrylic ideal for stocking Padlocks, Tags & Hasps. Configuration: 24 Hooks for Padlocks + 2 Tag Pockets (10 tags per pocket) + 2 Hooks (can store upto 2 Hasps per hook). Empty Station Only. Color: Yellow.
Dimensions:	L507 x W409 mm.
Brand: LOTO-LOK®	Origin: China
Weight:	Packaging:
	

Model No.:	LS-ACST-24L2P-CS
Description:	Lockout Station - Heavy duty acrylic construction, ideal for hanging Padlocks & Hasps. Clear pockets for Tags. 24 Padlocks + 20 Tags + Cable Ties + Marker Pen + 2 Hasps. Complete Station with contents. Color: Yellow.
Dimensions:	L507 x W409 mm.
Brand: LOTO-LOK®	Origin: China
Weight:	Packaging:
	

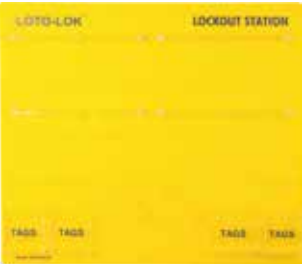
Model No.:	LS-ACST-48L4P-EB
Description:	Lockout Station - Heavy duty acrylic construction, ideal for stocking Padlocks, Tags & Hasps. Configuration: 48 Hooks for Padlocks + 4 Tag Pockets (10 Tags per pocket) + 2 Hooks (can store upto 2 Hasps per hook). Color: Yellow
Dimensions:	L685 x W604 mm.
Brand: LOTO-LOK®	Origin: China
Weight:	Packaging:
	

Model No.:	LS-ACST-48L4P-CS
Description:	Lockout Station - Heavy duty acrylic construction, ideal for hanging Padlocks & Hasps. Clear pockets for Tags. 48 Padlocks + 40 Tags + Cable Ties + Marker Pen + 4 Hasps. Complete Station with contents. Color: Yellow
Dimensions:	L685 x W604 mm.
Brand: LOTO-LOK®	Origin: China
Weight:	Packaging:
	

LOTO STATIONS

Model No.:	LS-MST04-EB
Description:	Lockout Station - Heavy duty molded plastic body with strong polycarbonate lockable cover.
	Ideal for stocking Padlocks, Hasps & Tags.
	Separate pocket stores Tags, Marker Pen & Cable Ties. Each hook can hang upto 2 Padlocks or Hasps. 5 Hooks + 1 Tag Pocket.
	Empty Station Only. Color: Yellow.
Dimensions: L320 x W420 x D70 mm.	
Brand:	Origin: China
Weight:	Packaging:
	

Model No.:	LS-MST04-CS
Description:	Lockout Station - Heavy duty molded plastic body with strong polycarbonate lockable cover.
	Ideal for stocking Padlocks & Hasps. Separate pocket stores Tags, Marker Pen & Cable Ties.
	Hooks are designed to hang 1 or 2 padlocks per hook. Can be customized to specific requirements.
	Complete Station with contents. Color: Yellow.
Dimensions: L320 x W420 x D70 mm.	
Brand:	Origin: China
Weight:	Packaging:
	

Model No.:	LS-MST10-EB
Description:	Lockout Station - Heavy duty molded plastic body with strong polycarbonate lockable cover.
	Ideal for stocking Padlocks, Hasps & Tags.
	Separate pocket stores Tags, Marker pen & Cable ties. Each hook can hang upto 2 Padlocks or Hasps. 15 Hooks + 2 Tag Pockets.
	Empty Station Only. Color: Yellow.
Dimensions: L400 x W560 x D70 mm.	
Brand:	Origin: China
Weight:	Packaging:
	

Model No.:	LS-MST10-CS
Description:	Lockout Station - Heavy duty molded plastic body with strong polycarbonate lockable cover.
	Ideal for stocking Padlocks & Hasps. Separate pocket stores Tags, Marker Pen & Cable Ties. Hooks are designed to hang 1 or 2 Padlocks per hook.
	Complete Station with contents.
	Color: Yellow.
Dimensions: L400 x W560 x D70 mm.	
Brand:	Origin: China
Weight:	Packaging:
	

Model No.:	LS-MST08P-EB	
Description:	Lockout Station - Polycarbonate w/cover. 8 Hooks to store Padlocks and Hasps (can store 2 padlocks / Hasps per hook) + bottom shelf to store Lockout / Tagout products.	
	Empty Station Only. Color: Yellow.	
	Dimensions: L574mm x W396mm x D108 mm.	
	Brand:	Origin: China
Weight:	Packaging:	
		

Model No.:	LS-SWC22H-4P
Description:	Lockout Station - Molded ABS + PC construction with locable door. Accommodate 20 Locks + 2 Hasps + 4 Tag Pockets.
	Color: Yellow. Station without contents.
Dimensions: L 625mm x W 590mm x D 97 mm.	
Brand: LOTO-LOK®	Origin: China.
Weight:	Packaging: 01 No.
	

Model No.:	LS-SWC22H-4P-CS
Description:	Lockout Station - Molded ABS + PC construction with locable door. 20 Padlocks, 2 Hasps, 40 Tags, Marker Pen & Cable Ties.
	Color: Yellow. Complete Station with contents.
Dimensions: L 625mm x W 590mm x D 97 mm.	
Brand: LOTO-LOK®	Origin: China.
Weight:	Packaging: 01 No.
	

Model No.:	LS-22H4PR
Description:	Lockout Station - Heavy duty Steel & powder coated construction with clear Acrylic Fascia. Accommodates 20 Locks + 2 Hasps + 4 Tag Pockets. Color: Red. Station without contents.
	Dimensions: 580mm x 430mm x 90mm.
Brand: LOTO-LOK®	Origin: China.
Weight:	Packaging: 01 No.
	

Model No.:	LS-22H4PR-CS
Description:	Lockout Station - Heavy duty Steel & powder coated construction with clear Acrylic Fascia. 20 Padlocks, 2 Hasps, 40 Tags, Marker Pen & Cable Ties. Color: Red. Complete Station with contents.
	Dimensions: 580mm x 430mm x 90mm.
Brand: LOTO-LOK®	Origin: China.
Weight:	Packaging: 01 No.
	

LOTO STATIONS

Model No.:	LS-MSTPT-EB
Description:	Lockout Station - Polycarbonate w/cover.
	8 Padlock Hooks and compartments to store Lockout / Tagout products.
	Color: Yellow. Empty Station Only.
Dimensions: L556mm x W280mm x D102 mm.	
Brand:	Origin: China
Weight:	Packaging:
	

Model No.:	LS-PRPPC-STN
Description:	Lockout Station - Polycarbonate construction w/cover.
	Portable + Wall hanging. Accomodate Padlocks + Tags or only Padlocks. Customizable.
	Color: Yellow. Station without contents.
Dimensions: L 408 mm x W 338 mm x D 98 mm	
Brand:	Origin: China.
Weight:	Packaging: 01 No.
	

Model No.:	LS-PRPPC-STN-CS
Description:	Lockout Station - Polycarbonate w/cover. Dual use & Adjustable, Portable + Wall hanging. Can be customized to accomodate padlocks + Tags or only Padlocks. Lockout / Tagout products.
	Color: Yellow. Station with contents.
	Dimensions: L 408 mm x W 338 mm x D 98 mm
Brand:	Origin: China
Weight:	Packaging:
	

Model No.:	LSM-6PD
Description:	Lockout Station - 6 Hooks for Padlocks / Hasps + 2 Tag Pockets and compartments to store LOTO products.
	Empty Station Only. Color: Yellow.
	Dimensions: L600 x W450 x D120 mm.
Brand: LOTO-LOK®	Origin: China
Weight:	Packaging:
	

Model No.:	LSM-10PD
Description:	Lockout Station - 10 Hooks for Padlocks / Hasps + 2 Tag Pockets and compartments to store LOTO products.
	Empty Station Only. Color: Yellow.
	Dimensions: L760 x W610 x D140 mm.
Brand: LOTO-LOK®	Origin: China
Weight:	Packaging:
	

Model No.:	LS-6CFY-EB
Description:	Lockout Station - Heavy duty steel construction, powder coated yellow, 2 adjustable shelves and door with clear acrylic fascia. Station is ideal for stocking a mix of Electrical & Mechanical LOTO Products. Empty Station Only. Color: Yellow.
	Dimensions: L360 x W450 x D155 mm.
	Brand: LOTO-LOK®
Weight:	Packaging:
	

Model No.:	LS-6STLY-EB
Description:	Lockout Station - Heavy duty steel construction, powder coated yellow, 2 adjustable shelves and Steel door. Station is ideal for stocking a mix of Electrical & Mechanical LOTO Products. Empty Station Only. Color: Yellow.
	Dimensions: L410 x W360 x D155 mm.
	Brand: LOTO-LOK®
Weight:	Packaging:
	

Model No.:	LS-10CFY
Description:	Lockout Station - Heavy duty steel construction, powder coated yellow, 2 adjustable shelves and door with clear acrylic fascia. Station is ideal for stocking a mix of Electrical & Mechanical LOTO Products. Empty Station Only. Color: Yellow.
	Dimensions: L600 x W550 x D250 mm.
	Brand: LOTO-LOK®
Weight:	Packaging:
	

Model No.:	LS-10STLY
Description:	Lockout Station - Heavy duty steel construction, powder coated yellow, 2 adjustable shelves and Steel door. Station is ideal for stocking a mix of Electrical & Mechanical LOTO Products. Empty Station Only. Color: Yellow.
	Dimensions: L600 x W550 x D250 mm.
	Brand: LOTO-LOK®
Weight:	Packaging:
	

LOTO STATIONS

Model No.:	LS-6CF-GLBY
Description:	Lockout Station - Clear Fascia with 2 adjustable shelves and Group Lock Box. Powder Coated Steel. Color: Yellow. Empty Box Only.
Dimensions: L 540 x W 360 x D 155 mm.	
Brand: LOTO-LOK®	Origin: China
Weight:	Packaging:
	

Model No.:	LS-STLY-9C-CF
Description:	Lockout Station - Heavy duty steel construction, powder coated yellow, 2 adjustable shelves, 5 Hooks for hanging Padlocks and door with clear acrylic fascia.
	Station is ideal for stocking a mix of Electrical & Mechanical LOTO Products.
	Empty Station Only. Color: Yellow.
Dimensions: L760 x W380 x D225 mm.	
Brand: LOTO-LOK®	Origin: India
Weight:	Packaging:
	

Model No.:	LS-STLR-9C-CF
Description:	Lockout Station - Heavy duty steel construction, powder coated red, 2 adjustable shelves, 5 Hooks for hanging Padlocks and door with clear acrylic fascia.
	Station is ideal for stocking a mix of Electrical & Mechanical LOTO Products.
	Empty Station Only. Color: Red.
Dimensions: L 765 x W 335 x D 235 mm.	
Brand: LOTO-LOK®	Origin: India
Weight:	Packaging:
	

Model No.:	LS-TRLY-MCY
Description:	Lockout Trolley - Portable, 2 wheels, 4 Compartments, for stocking various electrical & mechanical LOTO devices, Padlocks & Tags. Ideal & handy for shop floors
	where trolley can be wheeled on site. Reduces downtime.
Color: Yellow	
Dimensions: L 735 X W 490 X D 230 mm.	
Brand: LOTO-LOK®	Origin: China
Weight:	Packaging:
	

Model No.:	LTS-2S-PM-EB
Description:	Lockout Station - PP construction with handle. Portable + Wall mounting.
	Stores padlocks, devices & Tags.
Color: Yellow with lockable cover. Station without contents.	
Dimensions: L 430 x W 380 x H 150 mm.	
Brand:	Origin: China.
Weight:	Packaging: 01 No.
	

Model No.:	LS-8PTS
Description:	Tagout Station - 8 pockets. 8 clear acrylic pockets for accomodating tags upto 80mm width x 160mm length. Empty Station Only. Color: Yellow.
Dimensions: L 395 mm x W 445 mm.	
Brand: LOTO-LOK®	Origin: China
Weight:	Packaging:
	

LOTO STATIONS - SHADOW BOARDS

Model No.:	LS-SB6
Description:	Shadow Board - Aluminium frame. Cap: 6 Padlocks + 2 Hasps + 2 Tag Hooks.
	Empty Board Only.
Dimensions: L420 x W615 mm.	
Brand: LOTO-LOK®	Origin: China
Weight:	Packaging:



Model No.:	LS-SB6-CS
Description:	Shadow Board - Aluminium frame with 6 Padlocks + 2 Hasps + 20 Tags.
	Complete Station with contents.
Dimensions: L420 x W615 mm.	
Brand: LOTO-LOK®	Origin: China
Weight:	Packaging:



Model No.:	LS-SB12
Description:	Shadow Board - Aluminium frame. Cap: 12 Padlocks + 2 Hasps + 2 Tag Hooks.
	Empty Board Only.
Dimensions: L460 x W615 mm.	
Brand: LOTO-LOK®	Origin: China
Weight:	Packaging:



Model No.:	LS-SB12-CS
Description:	Shadow Board - Aluminium frame with 12 Padlocks + 2 Hasps + 20 Tags.
	Complete Station with contents.
Dimensions: L460 x W615 mm.	
Brand: LOTO-LOK®	Origin: China
Weight:	Packaging:



Model No.:	LS-SB24
Description:	Shadow Board - Aluminium frame. Cap: 24 Padlocks + 2 Hasps + 2 Tag Hooks.
	Empty Board Only.
Dimensions: L690 x W595 mm.	
Brand: LOTO-LOK®	Origin: China
Weight:	Packaging:



Model No.:	LS-SB24-CS
Description:	Shadow Board - Aluminium frame with 24 Padlocks + 2 Hasps + 20 Tags.
	Complete Station with contents.
Dimensions: L690 x W595 mm.	
Brand: LOTO-LOK®	Origin: China
Weight:	Packaging:



Model No.:	LS-SB36
Description:	Shadow Board - Aluminium frame. Cap: 36 Padlocks + 4 Hasps + 4 Tag Hooks.
	Empty Board Only.
Dimensions: L815 x W755 mm.	
Brand: LOTO-LOK®	Origin: China
Weight:	Packaging:



Model No.:	LS-SB36-CS
Description:	Shadow Board - Aluminium frame with 36 Padlocks + 4 Hasps + 40 Tags.
	Complete Station with contents.
Dimensions: L815 x W755 mm.	
Brand: LOTO-LOK®	Origin: China
Weight:	Packaging:





Model No.:	LS-SB50
Description:	Shadow Board - Aluminium frame. Cap: 50 Padlocks + 3 Hasps + 3 Tag Hooks.
	Empty Board Only.
Dimensions: L1000 x W735 mm.	
Brand: LOTO-LOK®	Origin: China
Weight:	Packaging:





LOTO STATIONS - SHADOW BOARDS

Model No.:	LS-SB50-CS
Description:	Shadow Board - Aluminium frame with 50 Padlocks + 3 Hasps + 30 Tags. Complete Station with contents.
Dimensions: L1000 x W735 mm.	
Brand: LOTO-LOK®	Origin: China
Weight:	Packaging:
	

Model No.:	LS-SB100
Description:	Shadow Board - Aluminium frame. Cap: 100 Padlocks + 5 Hasps + 4 Tag Hooks. 1 Acrylic pocket for pens, clips & screwdrivers. Empty Board Only.
Dimensions: L1300 x W1005 mm.	
Brand: LOTO-LOK®	Origin: China
Weight:	Packaging:
	

Model No.:	LS-SB100-CS
Description:	Shadow Board - Aluminium frame with 100 Padlocks + 5 Hasps + 40 Tags + Cable Ties + 1 Acrylic pocket for pens, clips & screwdrivers. Complete Station with contents.
Dimensions: L1300 x W1005 mm.	
Brand: LOTO-LOK®	Origin: China
Weight:	Packaging:
	

Model No.:	LS-SBEL
Description:	Shadow Board - Aluminium frame. Electrical Circuit Breaker Shadow Board. Cap: 4 Padlocks + 2 Hasps + 22 Circuit Breaker + 1 Tag Hook. Empty Board Only.
Dimensions: L450 x W600 mm.	
Brand: LOTO-LOK®	Origin: China
Weight:	Packaging:
	

Model No.:	LS-SBEL-CS
Description:	Shadow Board - Aluminium frame. Electrical Circuit Breaker Shadow Board with 4 Padlocks + 2 Hasps + 22 Circuit locking devices (various models) + 10 Tags. Complete Station with contents.
Dimensions: L450 x W600 mm.	
Brand: LOTO-LOK®	Origin: China
Weight:	Packaging:
	

Model No.:	LS-SBEM
Description:	Shadow Board - Electrical & Mechanical Shadow Board. Capacity: 8 Hooks for padlock + 10 Hooks for Hasp + 3 Hooks for Tag + 10 Hooks for Circuit Breaker Lockout + 3 Hooks for Cable Lockout + 5 Hooks for Gate Valve Lockout + 1 Acrylic Pocket. Empty Board Only.
Dimensions: L1220 x W840 mm.	
Brand: LOTO-LOK®	Origin: China
Weight:	Packaging:
	

Model No.:	LS-SBEM-CS
Description:	Shadow Board - Aluminium frame. Electrical & Mechanical with 8 Padlocks + 10 Hasps + 30 Tags + 10 Circuit Breaker Lockout Devices + 3 Cable Lockouts + 5 Gate Valve Lockouts + 1 Acrylic Pocket (with cable ties, marker pen & screwdriver). Complete Station with content.
Dimensions: L1220 x W840 mm.	
Brand: LOTO-LOK®	Origin: China
Weight:	Packaging:
	

Model No.:	LS-SB-EMCM
Description:	Lockout Shadow Board Construction - PPC board with Aluminium alloy frame. Can be used for hanging a wide selection of Electrical & Mechanical Lockouts. Empty Station without contents.
Dimensions: H 800 mm x W 1220 mm.	
Brand: LOTO-LOK®	Origin: China
Weight:	Packaging:
	

Model No.:	LS-SB-EMCM-CS
Description:	Lockout Shadow Board Construction - PPC board with Aluminium alloy frame. Wide range of LOTO padlocks, Devices & Tags for Electrical & Mechanical Isolation. Complete Station with contents.
Dimensions: H 800 mm x W 1220 mm.	
Brand: LOTO-LOK®	Origin: China
Weight:	Packaging:
	

LOTO STATIONS - SHADOW BOARDS

Model No.:	LS-SB-EMGB
Description:	Lockout Shadow Board Construction – PPC board with Aluminium alloy frame. Accommodates a wide range of LOTO products for Electrical & Mechanical Isolation. Molded plastic Group Lock Box
Box 29 padlocks capacity can be installed. Inbuilt Acrylic Pocket. Station without contents.	
Dimensions: H 800 mm x W 1600 mm.	
Brand: LOTO-LOK®	Origin: China
Weight:	Packaging:



Model No.:	LS-SB-EMGB-CS
Description:	Lockout Shadow Board Construction – PPC board with Aluminium alloy frame. Wide range of LOTO products + Molded Group Lock Box 29 padlocks capacity & Acrylic Pocket for Electrical & Mechanical Isolation. Complete Station with contents.
Dimensions: H 800 mm x W 1600 mm.	
Brand: LOTO-LOK®	Origin: China
Weight:	Packaging:



Model No.:	LS-PTW-DH-CS
Description:	Lockout Shadow Board Construction – PPC board with Aluminium alloy frame, Upper part accommodates 3 yellow acrylic PTW / Document holders with group locking facility, acrylic pocket at bottom stores documents. Complete Station.
Dimensions: L 1200 x W 900 mm.	
Brand: LOTO-LOK®	Origin: India
Weight:	Packaging:



Model No.:	LS-SB-PHGLBY3
Description:	Shadow Board - Aluminium frame. Group Lockout. Capacity: 3 Permit Holder + 3 Group Lockout Box + 24 Padlock + 3 Tag Hooks. Empty Board Only.
Dimensions: L1220 x W1220 mm.	
Brand: LOTO-LOK®	Origin: India
Weight:	Packaging:

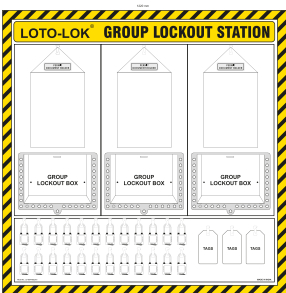

Model No.:	LS-SB-PHACP4
Description:	Shadow Board - Aluminium frame. Work Permit Station. Capacity: 4 Permit Document Holder + 4 Work Permit Holder Hooks. Empty Board Only.
Dimensions: L1200 x H900 mm.	
Brand: LOTO-LOK®	Origin: India
Weight:	Packaging:

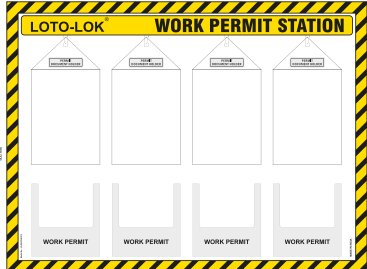

Model No.:	LS-SB-PHGLBR1
Description:	Shadow Board - Aluminium frame. Permit Control Board. Capacity: 1 Permit Document Holder Hook + 1 Group Lockout Box Holder. Empty Board Only.
Dimensions: L660 x W300 mm.	
Brand: LOTO-LOK®	Origin: India
Weight:	Packaging:

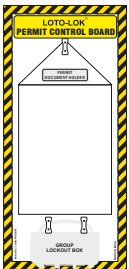

Model No.:	LS-SB-PHGLBY1
Description:	Shadow Board - Aluminium frame. Work Permit Station. Capacity: 1 Permit Document Holder Hook + 1 Group Lockout Box Holder. Empty Board Only.
Dimensions: L560 x W740 mm.	
Brand: LOTO-LOK®	Origin: India
Weight:	Packaging:

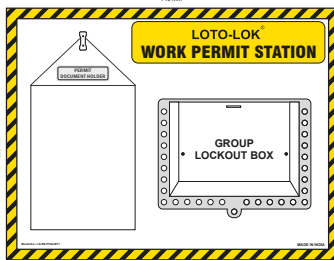

Model No.:	LS-SB-CLST4
Description:	Shadow Board - Aluminium frame. Cable Lockout Station Capacity: 4 Padlock + 2 Hasp + 1 Tag + 4 Cable Lockout Hooks. Empty Board Only.
Dimensions: L480 x W600 mm.	
Brand: LOTO-LOK®	Origin: India
Weight:	Packaging:

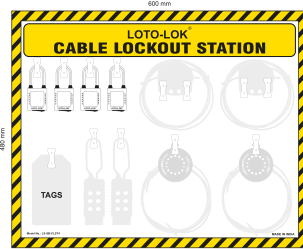

GROUP LOCKOUT STATIONS

Model No.:	GLB-SR13-TP
Description:	Group Lock Box - Steel, Powder coated RED color, accommodates 1 Primary & 12 secondary padlocks. Tag Pocket with
Chain holds 3 Tags for maintaining group locking details.	
Dimensions: L255 x W105 x H152mm.	
Brand: LOTO-LOK®	Origin: China
Weight:	Packaging:
	

Model No.:	GLB-SR13-NP
Description:	Group Lock Box - Steel, Powder coated RED color, accommodates 1 Primary & 12 secondary padlocks.
Dimensions: L255 x W105 x H152mm.	
Brand: LOTO-LOK®	Origin: China
Weight:	Packaging:
	

Model No.:	GLB-SR13B-NP
Description:	Group Lock Box - BIG (Portable), Red color powder coated, accommodates 1 Primary & 12 Secondary Padlocks.
Dimensions: 7.10" x 10" x 7.30"	
Brand: LOTO-LOK®	Origin: India
Weight:	Packaging: 01 No.
	

Model No.:	GLB-SY13-TP
Description:	Group Lock Box - Steel, Yellow color powder coated, accommodates 1 Primary & 12 Secondary Padlocks. Includes 3 Tags.
Dimensions: L 255 x W105 x H152mm.	
Brand: LOTO-LOK®	Origin: China
Weight:	Packaging:
	

Model No.:	GLB-SY13-NP
Description:	Group Lock Box - Steel, Yellow color powder coated, accommodates 1 Primary & 12 Secondary Padlocks. Includes 3 Tags.
Dimensions: L 255 x W105 x H152mm.	
Brand: LOTO-LOK®	Origin: China
Weight:	Packaging:
	

Model No.:	GLB-SRL7
Description:	Group Lock Box - Steel, Red color powder coated, accommodates 1 Primary & 6 Secondary Padlocks.
Dimensions: L110 x W100 x D185mm.	
Brand: LOTO-LOK®	Origin: China
Weight:	Packaging:
	

Model No.:	GLB-WMB-R5
Description:	Group Lock Box - Steel construction, Wall Mounted.Upper & lowers hangers accommodates upto 12 Padlocks. 5 molded hooks inside box can hang multiple keys. Station without contents. Color: Red.
Dimensions: 230mm x 150mm x 90mm.	
Brand: LOTO-LOK®	Origin: China.
Weight:	Packaging: 01 No.
	

Model No.:	GLB-WHMST-R
Description:	Group Lock Box - Steel Powder coated. 12 Built-in Keys Hanger. Accommodates 14 Padlocks outside. Color: Red.
Dimensions: L 163 x W 85 x D 260mm.	
Brand: LOTO-LOK®	Origin: China
Weight:	Packaging:
	

Model No.:	GLB-AL-83
Description:	Group Lock Box - Aluminium Const. with tough Polycarbonate sliding cover & PTW holder. Accommodates upto 83 Padlocks with 4 key Hooks. Color: Red.
Dimensions: L 680 x W 340 x D 35mm.	
Brand: LOTO-LOK®	Origin: China
Weight:	Packaging:
	

GROUP LOCKOUT STATIONS

Model No.:	GLB-PLX18
Description:	Group Lock Box - Acrylic construction
	Hinged door, 6 keys hangers. Portable. Accommodates 16 Padlocks. Color: Red.
Dimensions: L200 x W150 x D90mm.	
Brand:	Origin: China
Weight:	Packaging:
	

Model No.:	GLB-WHP21-R
Description:	Group Lock Box - ABS & PC construction.
	Hinged door, 4 keys hangers. Portable. Accommodates 8 Padlocks. Color: Red.
Dimensions: L100 x W115 x D155mm.	
Brand:	Origin: China
Weight:	Packaging:
	

Model No.:	GLB-WHP22-R
Description:	Group Lock Box - ABS & PC construction.
	Hinged door, 6 keys hangers with key drop facility. Portable. Color: Red.
Dimensions: L200 x W90 x D162mm.	
Brand:	Origin: China
Weight:	Packaging:
	

Model No.:	GLB-WM-7
Description:	Group Lock Box - Steel Powder coated.
	7 Key Hooks. Accommodates 7 Padlocks.
	Portable & Wall Mounting. Color: Red.
Dimensions: L 208 x W 208 x D 155mm.	
Brand: LOTO-LOK®	Origin: India.
Weight:	Packaging:
	

Model No.:	GLB-WH-12
Description:	Group Lock Box - Steel Powder coated.
	15 Key Hooks. Accommodates 12 Padlocks.
	Portable & Wall Mounting. Color: Red.
Dimensions: L238 x W432 x D60mm.	
Brand: LOTO-LOK®	Origin: India.
Weight:	Packaging:
	

Model No.:	GLB-GL-1-8K
Description:	Group Lock Box - Steel Powder coated.
	10 Key Hooks. Accommodates 10 Padlocks.
	Portable & Wall Mounting. Color: Red.
Dimensions: L310 x W305 x D80mm.	
Brand:	Origin: India.
Weight:	Packaging:
	

Model No.:	GLB-GLK-2
Description:	Group Lock Box - Steel Powder coated.
	10 Key Hooks. Accommodates 9 Padlocks
	Portable & Wall Mounting. Color: Red.
Dimensions: L 310 x W 305 x D 80mm.	
Brand: LOTO-LOK®	Origin: India.
Weight:	Packaging:
	

Model No.:	GLB-GLK-3
Description:	Group Lock Box - Steel Powder coated.
	40 Key Hooks. Accommodates 9 Padlocks
	Portable & Wall Mounting. Color: Red.
Dimensions: L 476 x W 318 x D 80mm.	
Brand: LOTO-LOK®	Origin: India.
Weight:	Packaging:
	

Model No.:	GLB-AR3KH
Description:	Group Lock Box - Acrylic construction
	with hinged door & 3 key hooks.
	Accommodates 5 Padlocks. Color: Red.
Dimensions: L150 x W150 x D60mm.	
Brand:	Origin: China
Weight:	Packaging:
	

GROUP LOCKOUT STATIONS

Model No.:	GLB-AR8KH
Description:	Group Lock Box - Acrylic construction with hinged door & 8 key hooks.
	Accommodates 8-10 Padlocks. Color: Red.
Dimensions: L 300 x W 190 x D 67mm.	
Brand:	Origin: China
Weight:	Packaging:



Model No.:	GLB-AR15KH
Description:	Group Lock Box - Acrylic construction with hinged door & 15 key hooks.
	Accommodates 10-15 Padlocks. Color: Red.
Dimensions: L 400 x W 190 x D 60mm.	
Brand:	Origin: China
Weight:	Packaging:

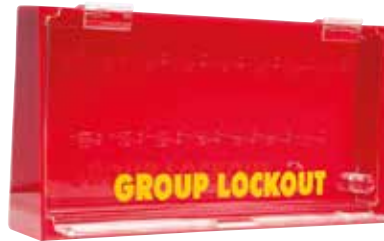

Model No.:	GLB-MB-4
Description:	Group Lock Box - SS304 Mini Box with 4 padlocks capacity. One Internal shelf accommodates keys and small fuses. Color: Yellow.
	Dimensions: L 158 mm x W 158 mm x D 54 mm.
Brand: LOTO-LOK®	Origin: China.
Weight:	Packaging: 01 No.



Model No.:	GLB-WMY-29H
Description:	Group Lock Box - Sliding door with key drop facility. Accommodates 29 Padlocks & 16 key hooks each. Color: Yellow.
	Dimensions: L 330 x W 265 x D 85mm.
Brand:	Origin: India.
Weight:	Packaging:



PADLOCK CABINETS

Model No.:	CABP-STLR-21-CF
Description:	Padlock Cabinet - 21 Locks Capacity.
	Durable Powder Coated Steel Cabinet with Clear Acrylic Fascia & 21 Hooks.
Dimensions: L450 x W375 x D100mm.	
Brand: LOTO-LOK®	Origin: India.
Weight:	Packaging:



Model No.:	CABP-STLR-28-CF
Description:	Padlock Cabinet - 28 Locks Capacity.
	Durable Powder Coated Steel Cabinet with Clear Acrylic Fascia & 28 Hooks.
Dimensions: L585 x W390 x D55mm.	
Brand: LOTO-LOK®	Origin: India.
Weight:	Packaging:



Model No.:	CABP-STLR-50-CF
Description:	Padlock Cabinet - 50 Locks Capacity.
	Durable Powder Coated Steel Cabinet with Clear Acrylic Fascia & 50 Hooks.
Dimensions: L 715 X W 505 X D 55 mm.	
Brand: LOTO-LOK®	Origin: India.
Weight:	Packaging:



Model No.:	CABP-STLR-60-CF
Description:	Padlock Cabinet - 60 Locks Capacity.
	Durable Powder Coated Steel Cabinet with Clear Acrylic Fascia & 60 Hooks.
Dimensions: L 860 X W 505 X D 55 mm.	
Brand: LOTO-LOK®	Origin: India.
Weight:	Packaging:



Model No.:	CABP-STLR-112
Description:	Padlock Cabinet - 112 Locks Capacity.
	Durable Powder Coated Cabinet with 112 Hooks & Steel door.
Dimensions: L584 x W393 x D139mm.	
Brand: LOTO-LOK®	Origin: India.
Weight:	Packaging:



Model No.:	CABP-STLR-220
Description:	Padlock Cabinet - 220 Locks Capacity.
	Durable Powder Coated Cabinet with 220 Hooks & Steel door.
Dimensions: L584 x W800 x D139mm.	
Brand: LOTO-LOK®	Origin: India.
Weight:	Packaging:



WALL MOUNTED PADLOCK STATIONS

Model No.:	PS-HANG6
Description:	Padlock Station - Wall mounted. 6 Locks Capacity. Color: Red
Dimensions: H 40 x W 140 x H 80mm.	
Brand: LOTO-LOK®	Origin: China
Weight:	Packaging:



Model No.:	PS-HANG12
Description:	Padlock Station - Wall mounted. 12 Locks Capacity. Color: Red
Dimensions: H 85 x W 27 x D 45mm.	
Brand: LOTO-LOK®	Origin: China
Weight:	Packaging:



Model No.:	PS-HANG18
Description:	Padlock Station - Wall mounted. 18 Locks Capacity. Color: Red
Dimensions: H 80 x W 400 x D 40mm.	
Brand: LOTO-LOK®	Origin: China
Weight:	Packaging:



Model No.:	PS-HANG24
Description:	Padlock Station - Wall mounted. 24 Locks Capacity. Color: Red
Dimensions: H 85 x W 530 x D 45mm.	
Brand: LOTO-LOK®	Origin: China
Weight:	Packaging:



KEY SAFE BOXES

Model No.:	KSB-3L
Description:	KEY SAFE BOX - 3 LOCK SYSTEM.
	1 Control Lock (KA) + 2 Secondary Locks (KD) with 2 internal shelves.
	1.2mm Steel Fabrication. Color: Grey.
Dimensions: H230 x W150 x D120mm.	
Brand: LOTO-LOK®	Origin: China
Weight:	Packaging:
	

Model No.:	KSB-5L
Description:	KEY SAFE BOX - 5 LOCK SYSTEM.
	1 Control Lock (KA) + 4 Secondary Locks (KD) with 2 internal shelves.
	1.2mm Steel Fabrication. Color: Grey.
Dimensions: H230 x W150 x D120mm.	
Brand: LOTO-LOK®	Origin: China
Weight:	Packaging:
	

Model No.:	KSB-7L
Description:	KEY SAFE BOX - 7 LOCK SYSTEM.
	1 Control Lock (KA) + 6 Secondary Locks (KD) with 2 internal shelves.
	1.2mm Steel Fabrication. Color: Grey.
Dimensions: H230 x W150 x D120mm.	
Brand: LOTO-LOK®	Origin: China
Weight:	Packaging:
	

Model No.:	KSB-5L300
Description:	KEY SAFE BOX - 5 LOCK SYSTEM.
	1 Control Lock (KA) + 4 Secondary Locks (KD) with 2 internal shelves.
	1.2mm Steel Fabrication. Color: Grey.
Dimensions: H305 x W305 x D104mm.	
Brand: LOTO-LOK®	Origin: China
Weight:	Packaging:
	

Model No.:	KSB-8L300
Description:	KEY SAFE BOX - 8 LOCK SYSTEM.
	1 Control Lock (KA) + 7 Secondary Locks (KD) with 2 internal shelves.
	1.2mm Steel Fabrication. Color: Grey.
Dimensions: H305 x W305 x D104mm.	
Brand: LOTO-LOK®	Origin: China
Weight:	Packaging:
	

Model No.:	KSB-5L300-H-STL
Description:	KEY SAFE BOX - 5 LOCK SYSTEM.
	1 Control Lock (KA) + 4 Secondary Locks (KD) with 28 Hooks for hanging keys. 1.2mm Mild Steel Fabrication. Color: Grey
Dimensions: H 305 x W 305 x D 104mm.	
Brand: LOTO-LOK®	Origin: China.
Weight:	Packaging: 01 No.
	

Model No.:	KSB-8L300-H-STL
Description:	KEY SAFE BOX - 8 LOCK SYSTEM.
	1 Control Lock (KA) + 4 Secondary Locks (KD) with 28 Hooks for hanging keys. 1.2mm Mild Steel Fabrication. Color: Grey
Dimensions: H 305 x W 305 x D 104mm.	
Brand: LOTO-LOK®	Origin: China.
Weight:	Packaging: 01 No.
	

Model No.:	KSB-5L300-H-SS
Description:	KEY SAFE BOX - 5 LOCK SYSTEM.
	1 Control Lock (KA) + 4 Secondary Locks (KD) with 28 Hooks for hanging keys. 1.2mm Stainless Steel 304 Fabrication. Color: Grey
Dimensions: H 305 x W 305 x D 104mm.	
Brand: LOTO-LOK®	Origin: China.
Weight:	Packaging: 01 No.
	

Model No.:	KSB-8L300-H-SS
Description:	KEY SAFE BOX - 8 LOCK SYSTEM.
	1 Control Lock (KA) + 4 Secondary Locks (KD) with 28 Hooks for hanging keys. 1.2mm Stainless Steel 304 Fabrication. Color: Grey
Dimensions: H 305 x W 305 x D 104mm.	
Brand: LOTO-LOK®	Origin: China.
Weight:	Packaging: 01 No.
	

LOK-FORCE™ KEY CABINETS

Model No.:	KC-LFLD-50
Description:	Key Cabinet - Rolled steel construction, Fixed hooks, 2 keys per lock, Plastic Key Tags & Wall mounting hardware included.
Dimensions:	240 x 300 x 75mm
Brand: LOK-FORCE™	Origin: China
Weight:	Packaging:



Model No.:	KC-LFHD-50
Description:	Key Cabinet - Rolled steel construction, Adjustable numbered hooks, 2 keys per lock, Plastic key Tags & Wall Mounting hardware included. Color: Grey.
Dimensions:	550 x 380 x 80mm
Brand: LOK-FORCE™	Origin: China
Weight:	Packaging:



Model No.:	KC-LFHD-100
Description:	Key Cabinet - Rolled steel construction, Adjustable numbered hooks, 2 keys per lock, Plastic key Tags & Wall Mounting hardware included. Color: Grey.
Dimensions:	550 x 380 x 80mm
Brand: LOK-FORCE™	Origin: China
Weight:	Packaging:



Model No.:	KC-LFHD-150
Description:	Key Cabinet - Rolled steel construction, Adjustable numbered hooks, 2 keys per lock, Plastic key Tags & Wall Mounting hardware included. Color: Grey.
Dimensions:	380 x 550 x 140mm
Brand: LOK-FORCE™	Origin: China
Weight:	Packaging:



Model No.:	KC-LFHD-200
Description:	Key Cabinet - Rolled steel construction, Adjustable numbered hooks, 2 keys per lock, Plastic key Tags & Wall Mounting hardware included. Color: Grey.
Dimensions:	380 x 550 x 140mm
Brand: LOK-FORCE™	Origin: China
Weight:	Packaging:



Model No.:	KC-LFHD-300
Description:	Key Cabinet - Rolled steel construction, Adjustable numbered hooks, 2 keys per lock, Plastic key Tags & Wall Mounting hardware included. Color: Grey.
Dimensions:	550 x 380 x 205mm
Brand: LOK-FORCE™	Origin: China
Weight:	Packaging:



Model No.:	KC-LFHD-400
Description:	Key Cabinet - Rolled steel construction, Adjustable numbered hooks, 2 keys per lock, Plastic key Tags & Wall Mounting hardware included. Color: Grey.
Dimensions:	730 x 550 x 140mm
Brand: LOK-FORCE™	Origin: China
Weight:	Packaging:



Model No.:	KC-LFHD-600
Description:	Key Cabinet - Rolled steel construction, Adjustable numbered hooks, 2 keys per lock, Plastic key Tags & Wall Mounting hardware included. Color: Grey.
Dimensions:	730 x 550 x 205mm
Brand: LOK-FORCE™	Origin: China
Weight:	Packaging:



Model No.:	KC-LFHD-1170
Description:	Key Cabinet - Rolled steel construction, Adjustable numbered hooks, 2 keys per lock, Plastic key Tags & Wall Mounting hardware included. Color: Grey.
Dimensions:	1300 x 730 x 250mm
Brand: LOK-FORCE™	Origin: China
Weight:	Packaging:



LOK-FORCE™ KEY CABINETS

Model No.:	KC-LFDKC-40
Description:	Key Cabinet Digital - Battery operated, Rolled steel construction, Fixed hooks with numbered key tags, 2 keys per lock, Plastic Key Tags & Wall mounting hardware included.
Dimensions:	270 x 308 x 65mm
Brand: LOK-FORCE™	Origin: China
Weight:	Packaging:



Model No.:	KC-LFDKC-60
Description:	Key Cabinet Digital - Battery operated, Rolled steel construction, Fixed hooks with numbered key tags, 2 keys per lock, Plastic Key Tags & Wall mounting hardware included.
Dimensions:	432 x 330 x 65mm
Brand: LOK-FORCE™	Origin: China
Weight:	Packaging:



Model No.:	KC-LFDKC-120
Description:	Key Cabinet Digital - Battery operated, Rolled steel construction, Fixed hooks with numbered key tags, 2 keys per lock, Plastic Key Tags & Wall mounting hardware included.
Dimensions:	375 x 432 x 65mm
Brand: LOK-FORCE™	Origin: China
Weight:	Packaging:



Model No.:	KC-LFEKC-3
Description:	Key Cabinet Emergency - Rolled steel construction, 3 fixed key hooks & hammer, 2 keys per lock, Plastic Key Tags & Wall mounting hardware included.
Dimensions:	120 x 150 x 80mm
Brand: LOK-FORCE™	Origin: China
Weight:	Packaging:

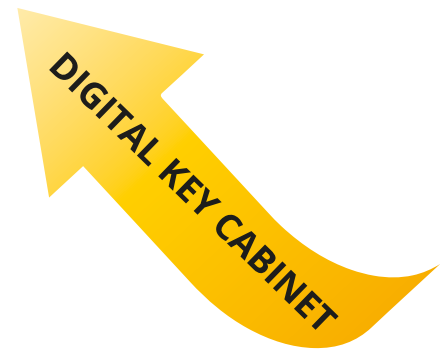

Model No.:	CAB-SB
Description:	Suggestion Box with external pocket for holding forms, Rolled steel construction, 2 keys per lock, Wall mounting hardware included.
Dimensions:	215 x 185 x 150mm
Brand: LOK-FORCE™	Origin: China
Weight:	Packaging:

Model No.:	KT-50
Description:	Plastic Key Tags - Normal. Assorted colors: Red, Yellow, Green, Blue, White & Black.
Dimensions:	
Brand: LOK-FORCE™	Origin: China
Weight:	Packaging:



Model No.:	KT-63
Description:	Plastic Key Tags - Heavy Duty Assorted colors: Red, Yellow, Green, Blue, White, Orange & Purple.
Dimensions:	
Brand: LOK-FORCE™	Origin: China
Weight:	Packaging:



Model No.:	KT-52
Description:	Plastic Key Tag - White slotted.
Dimensions:	
Brand: LOK-FORCE™	Origin: China
Weight:	Packaging:



KEY CABINETS

Model No.:	KCG10K
Description:	Key Cabinet - 10 Key Capacity, with plastic key tags and indexing card.
	Color: Grey.
Dimensions: W220 x D45 x H110mm.	
Brand: HELIX	Origin: China
Weight:	Packaging:
Till Stocks Last	
	

Model No.:	KCG20K
Description:	Key Cabinet - 20 Key Capacity, with plastic key tags and indexing card.
	Color: Grey.
Dimensions: W220 x D45 x H110mm.	
Brand: HELIX	Origin: China
Weight:	Packaging:
Till Stocks Last	
	

Model No.:	KCG30K
Description:	Key Cabinet - 30 Key Capacity, with plastic key tags and indexing card.
	Color: Grey.
Dimensions: W190 x D45 x H150mm.	
Brand: HELIX	Origin: China
Weight:	Packaging:
Till Stocks Last	
	

Model No.:	KCG80K
Description:	Key Cabinet - 80 Key Capacity, with plastic key tags and indexing card.
	Color: Grey.
Dimensions: W 275 x D 70 x H 275mm.	
Brand: HELIX	Origin: China
Weight:	Packaging:
Till Stocks Last	
	

Model No.:	KCG100K
Description:	Key Cabinet - 100 Key Capacity, with plastic key tags and indexing card.
	Color: Grey.
Dimensions: W 310 x D 70 x H 400mm.	
Brand: HELIX	Origin: China
Weight:	Packaging:
Till Stocks Last	
	

Model No.:	KC-30-CF
Description:	Key Cabinet - Manufactured by Metal Sheet with locking locking arrangement, 30 Keys Capacity with Clear Fascia.
Dimensions: L 360 x W 258 x D 55 mm.	
Brand: LOTO-LOK®	Origin: China.
Weight:	Packaging:
	

Model No.:	KC-60-CF
Description:	Key Cabinet - Manufactured by Metal Sheet with locking locking arrangement, 60 Keys Capacity with Clear Fascia.
Dimensions: L 460 x W 390 x D 55mm.	
Brand: LOTO-LOK®	Origin: China.
Weight:	Packaging:
	

Model No.:	KC-100-CF
Description:	Key Cabinet - Manufactured by Metal Sheet with locking locking arrangement, 100 Keys Capacity with Clear Fascia.
Dimensions: H 590 x W 520 x D 60 mm.	
Brand: LOTO-LOK®	Origin: China.
Weight:	Packaging:
	

Model No.:	KC-CF-320
Description:	Key Cabinet - 320 Keys capacity Durable Powder Coated Steel Cabinet with Clear Acrylic Fascia. Color: Yellow.
Dimensions: L 790 x W 460 x D 105mm.	
Brand: LOTO-LOK®	Origin: India
Weight:	Packaging:
	

LOTO POUCHES & BAGS

Model No.:	BG-RD21BP
Description:	LOTO BAG - Belt Pouch
	1680D Polyester heavy duty construction. 2 Pockets, Color: Red.
Dimensions:	20.5 x 10 x 14cms.
Brand: LOK-FORCE™	Origin: China
Weight:	Packaging:
	

Model No.:	BG-YW36MN
Description:	LOTO BAG - Mini Tote
	1680D Polyester heavy duty construction. Color: Yellow.
Dimensions:	36 x 13 x 15cms.
Brand: LOK-FORCE™	Origin: China
Weight:	Packaging:
	

Model No.:	BG-YR45SB
Description:	LOTO BAG - Shoulder
	1680D Polyester heavy duty construction. Multi pockets for organising different LOTO products & small tools. Color: Yellow/Red.
Dimensions:	45 x 22 x 32cms.
Brand: LOK-FORCE™	Origin: China
Weight:	Packaging:
	

Model No.:	BG-RD61WP
Description:	LOTO BAG - Waist Pouch - Heavy Duty,
	Extremely durable, Red color, 3 Pocket Waist Pouch manufactured from 1680D Grade Polyester. Color: Red
Dimensions:	61 x 16. x 17cms.
Brand: LOK-FORCE™	Origin: China
Weight:	Packaging:
	

Model No.:	BG-YR32SM
Description:	LOTO BAG - Hand Carry Bag - Small
	Heavy Duty Red color bag, Material 1680D Polyester. Color: Yellow / Red.
Dimensions:	31.5 x 23 x 27cms.
Brand: LOK-FORCE™	Origin: China
Weight:	Packaging:
	

Model No.:	BG-YR39MD
Description:	LOTO BAG - Hand Carry Bag - Medium
	Heavy Duty Red color bag, Material 1680D Polyester. Color: Yellow / Red.
Dimensions:	39 x 26 x 28cms.
Brand: LOK-FORCE™	Origin: China
Weight:	Packaging:
	

Model No.:	BG-YR47LG
Description:	LOTO BAG - Trolley Bag - Large
	Heavy duty construction w / Trolley Wheels. Material 1680D Polyester. Color: Yellow / Red.
Dimensions:	45 x 27 x 30cms.
Brand: LOK-FORCE™	Origin: China
Weight:	Packaging:
	

Model No.:	BG-RD62EG
Description:	Electrical Gear Bag - Duffle Tote
	Color: Red. With Silk Screen printed "ELECTRICAL GEAR" on front side of bag.
Dimensions:	62 x 32 x 37cms.
Brand: LOK-FORCE™	Origin: China
Weight:	Packaging:
	

★
POUCHES & BAGS CAN BE CUSTOMIZED WITH COMPANY NAMES / LOGOS BASED ON MINIMUM QUANTITIES.
★

E-MAIL: INFO@LOTOSAFETYPRODUCTS.COM

LOCKOUT / TAGOUT COMPLIANCE CENTRES

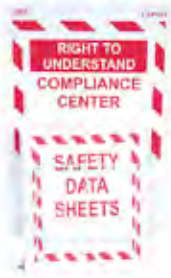
Model No.:	LSP-01
Description:	SDS STATION - Safety Data Sheets
	includes PVC coated wire rack on panel
	panel + one binder to store up to 300 data sheets.
Dimensions: L 585 X W 355 X D 115 mm.	
Brand: LOTO-LOK®	Origin: India
Weight:	Packaging:
	

Model No.:	LSP-02
Description:	SDS STATION - Safety Data Sheets
	includes PVC coated wire rack on panel
	+ two binders to store up to 600 data sheets.
Dimensions: L 555 X W 740 X D 115 mm.	
Brand: LOTO-LOK®	Origin: India
Weight:	Packaging:
	

Model No.:	MSDS-9000-07	
Description:	SDS STATION - Document Storage Box	
	(Empty Box Only).	
Color: Red.		
Dimensions: 11" x 8.5" x 1.63".		
Brand: Manual-Pak by Custom-Pak	Origin: USA	
Weight:	Packaging:	
		

SCAFFOLDING, LADDER & MICROTAGS

Model No.:	TAG-SCAF-THI
Description:	SCAFFOLDING TAG - HOLDER.
	Material: ABS/PA6.
Size : L 305mm x W 92mm.	
Brand: LOTO-LOK®	Origin: China
Weight:	Packaging:



Model No.:	TAG-SCAF-THI
Description:	SCAFFOLDING TAG - INSERT.
	Material: PVC.
Size : L 210mm x W 85mm.	
Brand: LOTO-LOK®	Origin: China
Weight:	Packaging:



Model No.:	TAG-SCAFF-BOX
Description:	SCAFFOLDING TAG HOLDER & INSERT
	Holder Material: ABS/PA6. Insert Material: PVC.
Size :	
Brand: LOTO-LOK®	Origin: China
Weight:	Packaging:

Packaging: 10 Nos. Holders + 20 Nos. Inserts + 02 Nos. Marker Pen per BOX



Model No.:	TAG-LADR-THI
Description:	LADDER INSPECTION - HOLDER.
Size: L 183mm x W 55.7mm.	
Brand:	Origin: China
Weight:	Packaging:



Model No.:	TAG-LADR-THI
Description:	LADDER INSPECTION - INSERT.
Size: L 183mm x W 52mm.	
Brand:	Origin: China
Weight:	Packaging:



Model No.:	TAG-MICR-THI
Description:	Microtag Holder & Insert with Cable Tie.
Size: L 81mm x W 39mm.	
Brand:	Origin: China
Weight:	Packaging:



Model No.:	DH-ACY-YELLOW
Description:	Document Holder - with Clear Door and Group Locking facility. Acrylic construction. Wall mounting. Color: Yellow.
Dimensions: L410 X W260mm.	
Brand: LOTO-LOK®	Origin: China
Weight:	Packaging:



Model No.:	DH-PVC-PTW
Description:	Document Holder - Flexible Sheeting Permit Holder with zip lock & metal eyelet. PTW can be secured with uniquely numbered color coded cable ties.
Dimensions: L325 mm x W290mm.	
Brand: LOTO-LOK®	Origin: China
Weight:	Packaging:





LOTO VINYL STICKERS

Model No.:	RWV-01
Description:	STICKER VINYL - Lockout / Tagout
	Self-Adhesive LOTO Sticker, stick on Equipment & Machines as Visual Aids.
Dimensions: L300 x W150mm. Type: Vertical.	
Brand: LOTO-LOK®	Origin: India
Weight:	Packaging:
	

Model No.:	RWH-02
Description:	STICKER VINYL - Lockout / Tagout
	Self-Adhesive LOTO Sticker, stick on Equipment & Machines as Visual Aids.
Dimensions: W300 x L150mm. Type: Horizontal.	
Brand: LOTO-LOK®	Origin: India
Weight:	Packaging:
	

Model No.:	BWH-03
Description:	STICKER VINYL - Lockout / Tagout
	Self-Adhesive LOTO Sticker, stick on Equipment & Machines as Visual Aids.
Dimensions: W300 x L150mm. Type: Horizontal.	
Brand: LOTO-LOK®	Origin: India
Weight:	Packaging:
	

Model No.:	BWV-04
Description:	STICKER VINYL - Lockout / Tagout
	Self-Adhesive LOTO Sticker, stick on Equipment & Machines as Visual Aids.
Dimensions: L300 x W150mm. Type: Vertical.	
Brand: LOTO-LOK®	Origin: India
Weight:	Packaging:
	

Model No.:	BWH-05
Description:	STICKER VINYL - Lockout / Tagout
	Self-Adhesive LOTO Sticker, stick on Equipment & Machines as Visual Aids.
Dimensions: W300 x L150mm. Type: Horizontal.	
Brand: LOTO-LOK®	Origin: India
Weight:	Packaging:
	

Model No.:	RBH-06
Description:	STICKER VINYL - Lockout / Tagout
	Self-Adhesive LOTO Sticker, stick on Equipment & Machines as Visual Aids.
Dimensions: W300 x L150mm. Type: Horizontal.	
Brand: LOTO-LOK®	Origin: India
Weight:	Packaging:
	

Model No.:	RBV-07
Description:	STICKER VINYL - Lockout / Tagout
	Self-Adhesive LOTO Sticker, stick on Equipment & Machines as Visual Aids.
Dimensions: L300 x W150mm. Type: Vertical.	
Brand: LOTO-LOK®	Origin: India
Weight:	Packaging:
	

Model No.:	BBH-08
Description:	STICKER VINYL - Lockout / Tagout
	Self-Adhesive LOTO Sticker, stick on Equipment & Machines as Visual Aids.
Dimensions: W300 x L150mm. Type: Horizontal.	
Brand: LOTO-LOK®	Origin: India
Weight:	Packaging:
	

Model No.:	YRH-09
Description:	STICKER VINYL - Lockout / Tagout
	Self-Adhesive LOTO Sticker, stick on Equipment & Machines as Visual Aids.
Dimensions: W300 x L150mm. Type: Horizontal.	
Brand: LOTO-LOK®	Origin: India
Weight:	Packaging:
	

LOTO VINYL STICKERS

Model No.:	RBH-10
Description:	STICKER VINYL - Lockout / Tagout
	Self-Adhesive LOTO Sticker, stick on Equipment & Machines as Visual Aids.
Dimensions: W300 x L150mm. Type: Horizontal.	
Brand: LOTO-LOK®	Origin: India
Weight:	Packaging:



Model No.:	RBH-11
Description:	STICKER VINYL - Lockout / Tagout
	Self-Adhesive LOTO Sticker, stick on Equipment & Machines as Visual Aids.
Dimensions: W300 x L150mm. Type: Horizontal.	
Brand: LOTO-LOK®	Origin: India
Weight:	Packaging:



Model No.:	YBH-12
Description:	STICKER VINYL - Lockout / Tagout
	Self-Adhesive LOTO Sticker, stick on Equipment & Machines as Visual Aids.
Dimensions: W300 x L150mm. Type: Horizontal.	
Brand: LOTO-LOK®	Origin: India
Weight:	Packaging:



Model No.:	RBH-13
Description:	STICKER VINYL - Lockout / Tagout
	Self-Adhesive LOTO Sticker, stick on Equipment & Machines as Visual Aids.
Dimensions: W300 x L150mm. Type: Horizontal.	
Brand: LOTO-LOK®	Origin: India
Weight:	Packaging:

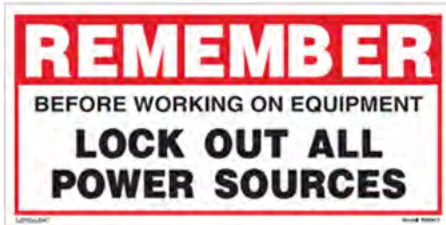

LOTO POSTERS

Model No.:	LP-01
Description:	POSTER - Lockout / Tagout. Made from durable Vinyl (Vertical).
Dimensions: L 600 x W 450mm.	
Brand: LOTO-LOK®	Origin: India
Weight:	Packaging:
	

Model No.:	LP-02
Description:	POSTER - Lockout / Tagout. Made from durable Vinyl (Vertical).
Dimensions: L 600 x W 450mm.	
Brand: LOTO-LOK®	Origin: India
Weight:	Packaging:
	

Model No.:	LP-03
Description:	POSTER - Lockout / Tagout. Made from durable Vinyl (Vertical).
Dimensions: L 600 x W 450mm.	
Brand: LOTO-LOK®	Origin: India
Weight:	Packaging:
	

Model No.:	LP-04
Description:	POSTER - Lockout / Tagout. Made from durable Vinyl (Vertical).
Dimensions: L 600 x W 450mm.	
Brand: LOTO-LOK®	Origin: India
Weight:	Packaging:
	

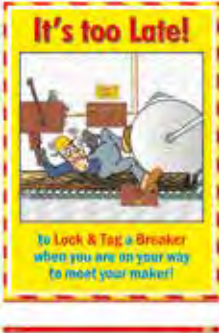
Model No.:	LP-05
Description:	POSTER - Lockout / Tagout. Made from durable Vinyl (Vertical).
Dimensions: L 600 x W 450mm.	
Brand: LOTO-LOK®	Origin: India
Weight:	Packaging:
	

Model No.:	LP-06
Description:	POSTER - Lockout / Tagout. Made from durable Vinyl (Vertical).
Dimensions: L 600 x W 450 mm.	
Brand: LOTO-LOK®	Origin: India
Weight:	Packaging:
	

Model No.:	LP-07
Description:	POSTER - Lockout / Tagout. Made from durable Vinyl (Vertical).
Dimensions: L 600 x W 450mm.	
Brand: LOTO-LOK®	Origin: India
Weight:	Packaging:
	

ELECTRIC SHOCK & CRANE SAFETY POSTERS

Model No.:	EL-01
Description:	Poster - Electric Shock (Vertical).
	GB Standard, Manufactured from durable plastic laminate
Dimensions: 750 x 500mm.	
Brand: LOTO-LOK®	Origin: India
Weight:	Packaging:
	

Model No.:	EL-02
Description:	Tips Poster - Electric Safety (Vertical).
Dimensions: 750 x 500mm.	
Brand: LOTO-LOK®	Origin: India
Weight:	Packaging:
	

Model No.:	EL-04
Description:	Poster - Electric Shock (Vertical).
Dimensions: 750 x 500mm.	
Brand: LOTO-LOK®	Origin: India
Weight:	Packaging:
	

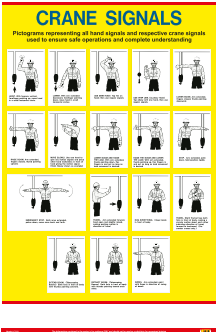
Model No.:	CS-01
Description:	Poster - Crane Signals (Vertical).
Dimensions: 750 x 500mm.	
Brand: LOTO-LOK®	Origin: India
Weight:	Packaging:
	

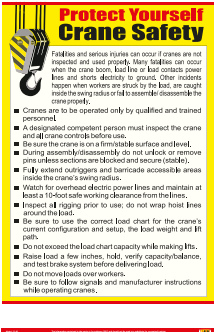
Model No.:	CS-02
Description:	Poster - Crane Safety (Vertical).
Dimensions: 750 x 500mm.	
Brand: LOTO-LOK®	Origin: India
Weight:	Packaging:
	

FIRST AID POSTERS

Model No.:	FA-01
Description:	Poster - First Aid Eye Injuries (Vertical).
Dimensions:	750 x 500mm.
Brand: LOTO-LOK®	Origin: India
Weight:	Packaging:

Model No.:	FA-02
Description:	Poster - First Aid Chemical and Caustics (Vertical).
Dimensions:	750 x 500mm.
Brand: LOTO-LOK®	Origin: India
Weight:	Packaging:

Model No.:	FA-03
Description:	Poster - First Aid Burns and Scalds (Vertical).
Dimensions:	750 x 500mm.
Brand: LOTO-LOK®	Origin: India
Weight:	Packaging:

Model No.:	FA-04
Description:	Poster - First Aid Chest Injuries (Vertical).
Dimensions:	750 x 500mm.
Brand: LOTO-LOK®	Origin: India
Weight:	Packaging:

Model No.:	FA-05
Description:	Poster - First Aid Artificial Respiration (Vertical).
Dimensions:	750 x 500mm.
Brand: LOTO-LOK®	Origin: India
Weight:	Packaging:

Model No.:	FA-06
Description:	Poster - First Aid Neck and Back Injuries (Vertical).
Dimensions:	750 x 500mm.
Brand: LOTO-LOK®	Origin: India
Weight:	Packaging:

Model No.:	FA-07
Description:	Poster - First Aid Stomach Injuries (Vertical).
Dimensions:	750 x 500mm.
Brand: LOTO-LOK®	Origin: India
Weight:	Packaging:

Model No.:	FA-08
Description:	Poster - First Aid Heart Attacks (Vertical).
Dimensions:	750 x 500mm.
Brand: LOTO-LOK®	Origin: India
Weight:	Packaging:

Model No.:	FA-09
Description:	Poster - First Aid Head Injuries and Nosebleeds (Vertical).
Dimensions:	750 x 500mm.
Brand: LOTO-LOK®	Origin: India
Weight:	Packaging:

FIRST AID POSTERS

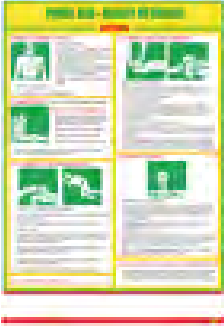
Model No.:	FA-10
Description:	Poster - First Aid Bleeding Cuts and Wounds (Vertical).
Dimensions: 750 x 500mm.	
Brand: LOTO-LOK®	Origin: India
Weight:	Packaging:
	

Model No.:	FA-11
Description:	Poster - First Aid Fits, Convulsions and Choking (Vertical).
Dimensions: 750 x 500mm.	
Brand: LOTO-LOK®	Origin: India
Weight:	Packaging:
	

Model No.:	FA-12
Description:	Poster - First Aid Fractures Dislocations and Sprains (Vertical).
Dimensions: 750 x 500mm.	
Brand: LOTO-LOK®	Origin: India
Weight:	Packaging:
	

Model No.:	FA-13
Description:	Poster - First Aid Transporting the Injured (Vertical).
Dimensions: 750 x 500mm.	
Brand: LOTO-LOK®	Origin: India
Weight:	Packaging:
	

LOCKOUT / TAGOUT & ARC FLASH PPE SAVES LIVES

Is your facility compliant to OSHA 29 CFR 1910.147 standard?

LOCKOUT / TAGOUT

 **Electrical Lockouts**

 **Mechanical Lockouts**

 **Safety Padlocks**

 **Danger Tags**

 **Group Lockout**

 **Identification**

 **Assessment**

 **Demonstration**

 **Supply**

 **Installation Support**

LOTO DEVICES, PADLOCKS AND TAGS FOR ISOLATION OF HAZARDOUS ENERGY



Safety Lockout Padlocks



Lockout Hasps



Circuit Breaker Lockouts



KAB-O-LOK Cable Lockouts



Mechanical Lockouts



Plug Lockouts



Panel Lockouts



Group Lock Box



Key Safe Box



Loto Stations



Key & Padlock Cabinets



Lockout Tags

ELECTRICAL SAFETY SOLUTIONS ARC FLASH PROTECTION PPE



Wall Mounted Rescue Kit



Arc Rated Balaclava



Arc Rated Helmet & Visor



CEI IEC 61243-1 Contact Voltage Detectors



Earthing & Short circuiting kits



Voltage Detectors



LOTO SAFETY REQUISITES TRADING L.L.C.

Belresheed Warehouse No.7, Next To Jacky's Electronics, Nad Al Hamar, P.O Box 114738, Dubai - UAE

Tel: +971-4-4539779 E-mail: info@lotosafetyproducts.com www.lotosafetyproducts.com



ENERGY ISOLATION LOCKOUT TAGOUT PADLOCKS

3PTP PREMIUM



ECONOMY



MINI



CABLE



ALUMINIUM



STEEL



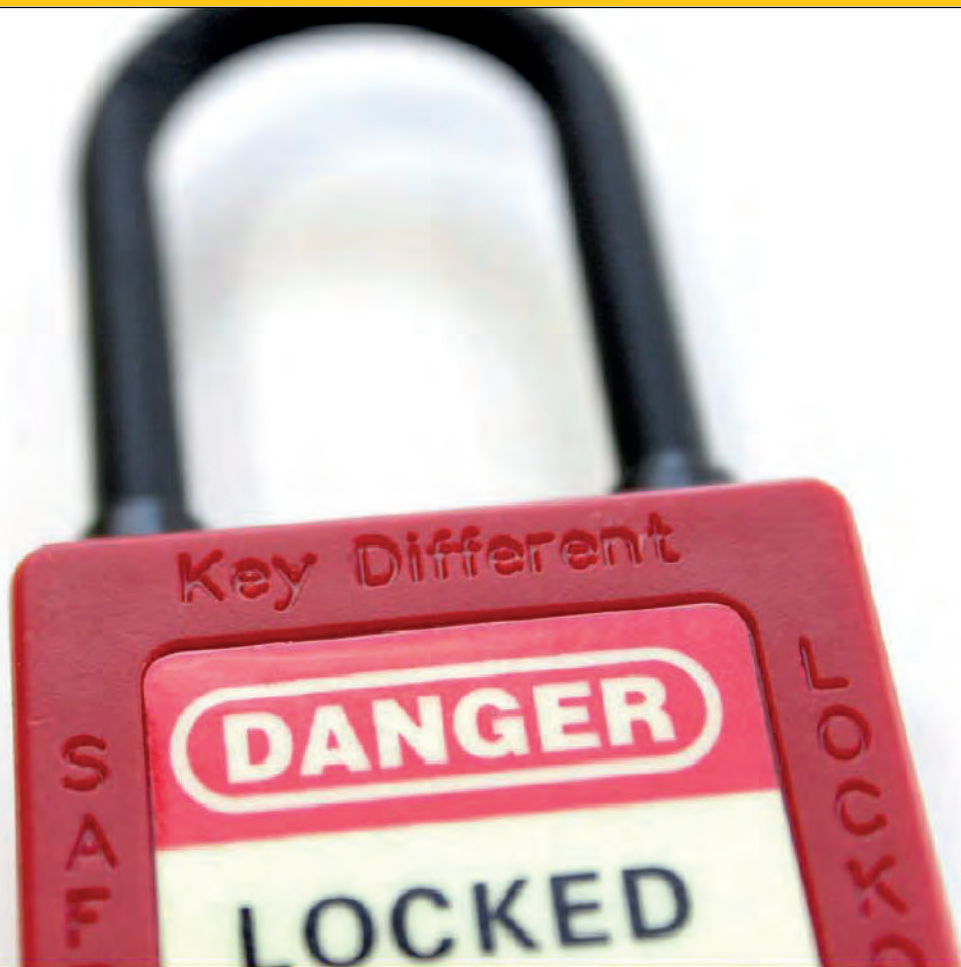

LOTO-LOK[®]

3PTP PLASTIC SAFETY LOCKOUT PADLOCKS



3PTP[®] 3 POINT TRACEABILITY PADLOCK



1
Key system is molded on padlock body & laser engraved on key. Visible key system allows user to initiate immediate action for lost or misplaced keys.

5.0mm shackle diameter permits easy access through small apertures

Weather Resistant Features
BODY-GARD bushes and Key Hole Cover resists dust, grime, moisture and erosive grit ingress into padlock body. Enhances padlock life



2
Key Number permanently lasered on padlock body and on key permits quick traceability of Key to Padlock.

Dimple key design provides smooth access & enhanced security. Key retaining facility prevents key loss



NON SPARK BODY

3
Color coded key jackets reduces downtime identifying keys to different color padlocks. Keys can be stocked by color code enabling quick access from Key Cabinets.



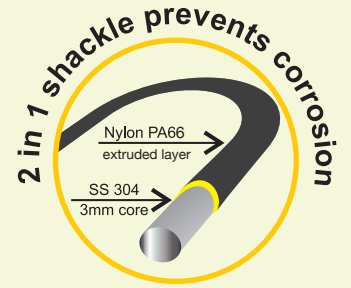

The **DUO 2-in-1 non-conductive** shock, rust & weather proof nylon shackle with a Stainless Steel 304 inner core has higher cut resistance than traditional plastic shackles which can be easily destroyed.



DUO 2-in-1

NON-CONDUCTIVE SHACKLE

COMBINES

THE STRENGTH OF
STAINLESS STEEL

&

DI-ELECTRIC PROPERTIES
OF NYLON

**Suitable for both Electrical
& Mechanical LOTO**



LOTO-LOK®



BODY: Tough Nylon PA66 construction. Non-spark, non-conductive, rust & weather body. Stands upto drops. Withstands upto 250 Deg. C temperature, UV & chemical resistant. Optimal in erosive & corrosive environment. Ideal for long term outdoor LOTO.

Name, Numbers or logo customization available.

Cylinder: 6 pin pick resist cylinder, upto 5000 keyed Different combinations in each color 40mm and 80mm shackle lengths.

Glow-in-The-Dark photo luminescent sticker enhances visibility in dark or low light conditions.

Eight colors: Red, Blue, Yellow, Green, Orange, Black, Purple & White.

Key Retaining feature ensures keys cannot be removed until padlocks are closed.

Shackle Material: SS304 (rust and cut resistant) OR Non-Conductive shackle.

KEYS: 2 Unique keys with every Keyed Different (KD) padlock & 1 key with every Keyed Alike (KA) Padlock.

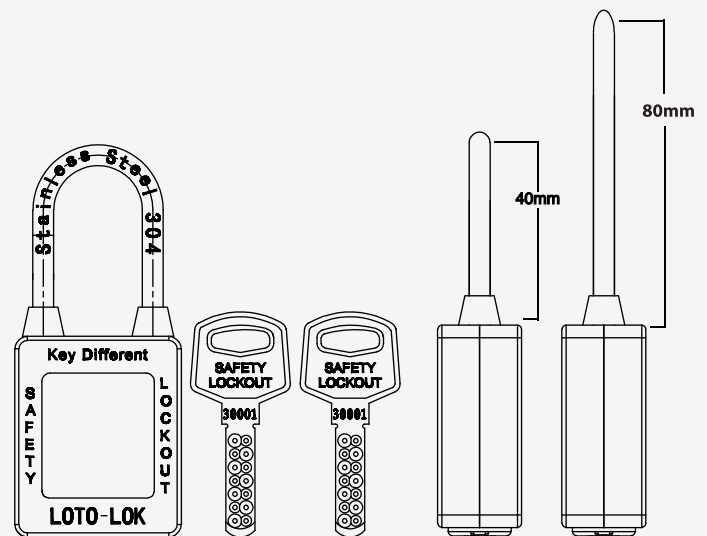

REGULAR SHACKLE DIMENSIONS

Size (mm)	Body Width (mm)	Body Thk. (mm)	Body Length (mm)	Total Height (mm)	Shackle Height (mm)	Shackle Dia. (mm)
40mm	40.00	20.00	48.20	94.20	40.00	5.00

LONG SHACKLE DIMENSIONS

Size (mm)	Body Width (mm)	Body Thk. (mm)	Body Length (mm)	Total Height (mm)	Shackle Height (mm)	Shackle Dia. (mm)
40mm	40.00	20.00	48.20	134.20	80.00	5.00

3PTP[®] PADLOCK KEY SYSTEMS

KEYED DIFFERENT (KD)

Each Keyed Different padlock operates with a unique key ensuring the highest security for the end user.

This means all locks are **uniquely keyed**, a key of one lock will not fit any other lock in the same or different color groups.

Locks have to be destroyed if keys are lost or misplaced.

Each color group in the 3PTP[®] range has up to 5000 unique Key Different combinations.

3PTP[®] padlocks in Keyed Different system come with 2 Unique keys with each padlock.

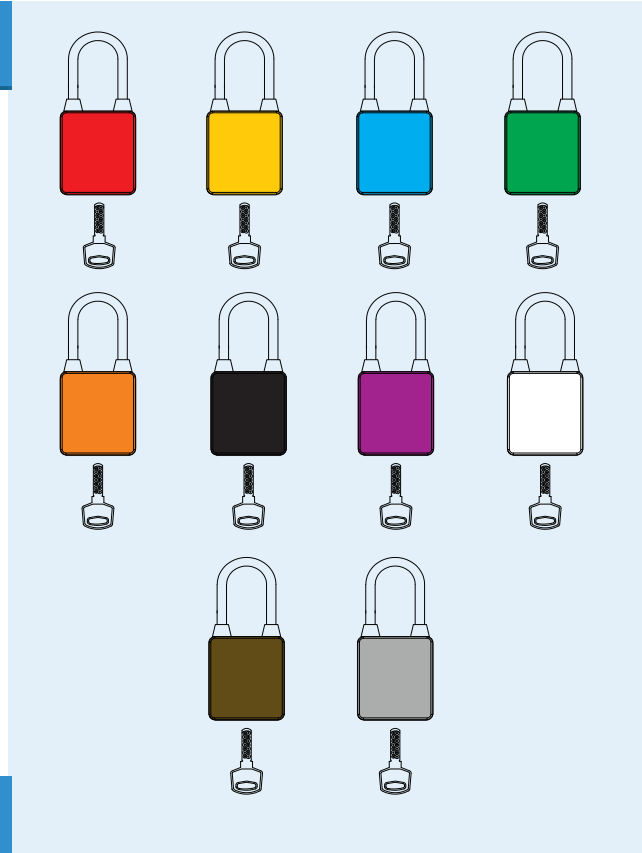

KEYED ALIKE (KA)

Keyed Alike padlocks operate with a common key, one key opens all locks in the same number group.

Ideal for situations where one employee is authorized for locking out different energy sources during LO/TO operations. One Key opens all locks reducing downtime on maintaining records of different keys.

However "same key" convenience could pose problems if keys can be accessed by other employees as it could compromise individual security.

KA padlocks can be customized per group **OR** color. Groups start from 2 or more padlocks to several hundreds, each KA group operates with a Different Keyed Alike Key.

Specify number of Groups and quantity of locks per group when ordering.

3PTP[®] padlocks in Keyed Alike system come with 1 Key Alike with each padlock.

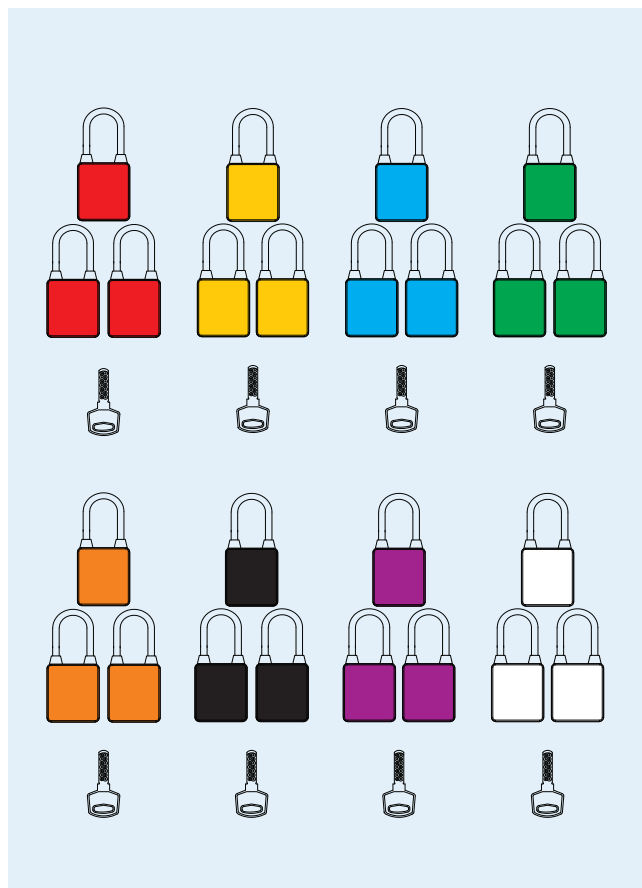

KEYED DIFFERENT & MASTER KEYED (KD&MK)

Each lock in a KD+MK system is Uniquely Keyed and also has an override Master Key which opens all locks in a particular color group irrespective of the shackle type or length.

This permits organizing master key systems along departmental or other functional lines to allow supervisory or emergency access.

Master Keys are coded per color, making it easier to order spare MK's at a later stage by stating the color of the lock.

Groups of locks with separate Master Keys cannot be generated in the 3PTP® system.

All 3PTP® padlocks in Keyed Different + Master Keyed system come with 2 Unique Keys per padlock as standard.

Master Keys are available in 1 or multiples and ordered separately.

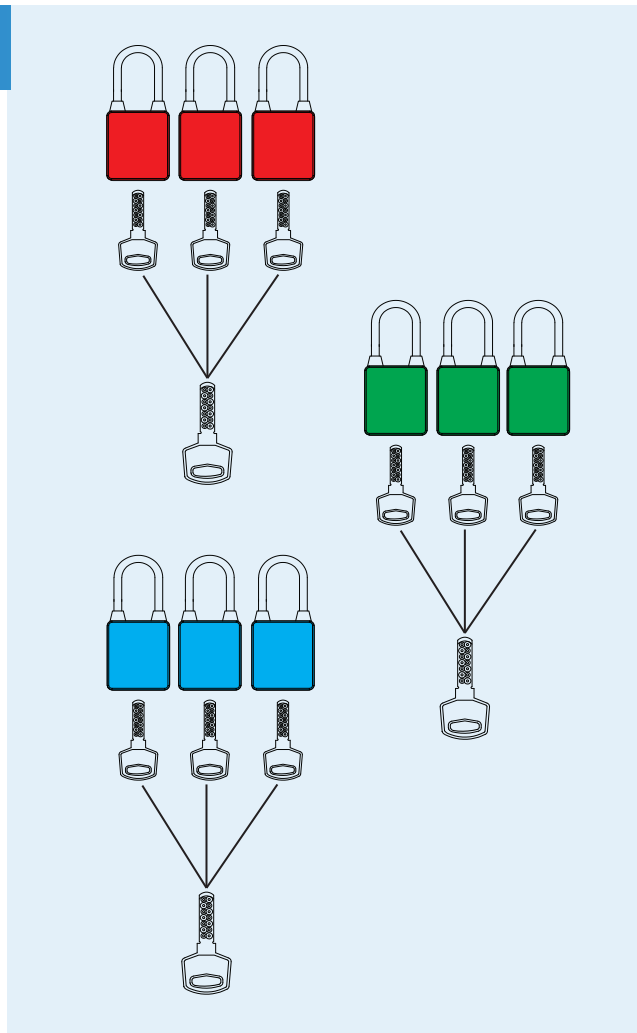

KEYED ALIKE & MASTER KEYED (KA&MK)

Each group of lock in KA+MK system opens with a separate keyed Alike key in the same color range.

A Master key opens all groups of differently keyed Alike locks in the same color.

All 3PTP® padlocks in keyed Alike + Master keyed system come with 1 Key Alike per padlock as standard.

Master Keys are available in 1 or multiples and are ordered separately.

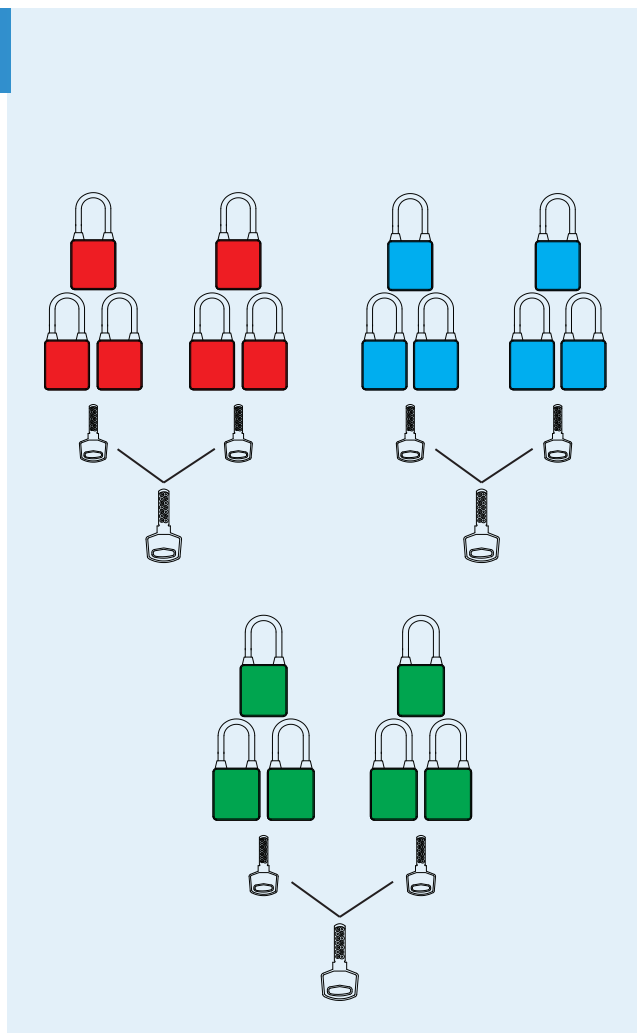



3PTP[®] PADLOCK SELECTION GUIDE

- Padlock selection plays an important role in LOTO Programs.
- The 3PTP[®] padlock range consists of 96 variations comprising color, shackle type, length and key systems.
- Selecting padlocks for different environs and energy sources is easy with the legends providing details of each alphabet / number.
- 8 Colors, 3 Key systems, 2 Shackle types and lengths are defined in the model numbers.

3 → 3

P → POINT

T → TRACEABILITY

P → PADLOCK

R → COLOR: RED

R	B	Y	G	N	O	P	W	BN	GY
Red	Blue	Yellow	Green	Noir (Black)	Orange	Purple	White	Brown	Grey

K
D → KEYED DIFFERENT

K D	K A	K D M K
Keyed Different	Keyed Alike	Keyed Different & Master Keyed

R
4
0 → REGULAR SHACKLE
(40mm Shackle Length
SS304 Grade)

R 4 0	L 8 0	N 4 0	N 8 0
REGULAR SHACKLE (40mm Shackle Length SS304 Grade)	LONG SHACKLE (80mm Shackle Length SS304 Grade)	NON-CONDUCTIVE SHACKLE (40mm Shackle Length)	LONG SHACKLE (80mm Shackle Length)



3PTP[®] PADLOCK MODEL NUMBERS

KEYED DIFFERENT

Color	Shackle: SS304 Grade REGULAR: 40mm Height	Shackle: SS304 Grade LONG: 80mm Height	Shackle: Non Conductive REGULAR: 40mm Height	Shackle: Non Conductive LONG: 80mm Height
	MODEL No.	MODEL No.	MODEL No.	MODEL No.
RED	3TPRKDR40	3TPRKDL80	3TPRKDN40	3TPRKDN80
YELLOW	3TPYKDR40	3TPYKDL80	3TPYKDN40	3TPYKDN80
BLUE	3TPBKDR40	3TPBKDL80	3TPBKDN40	3TPBKDN80
GREEN	3TPGKDR40	3TPGKDL80	3TPGKDN40	3TPGKDN80
ORANGE	3TPOKDR40	3TPOKDL80	3TPOKDN40	3TPOKDN80
NOIR (Black)	3TPNKDR40	3TPNKDL80	3TPNKDN40	3TPNKDN80
PURPLE	3TPPKDR40	3TPPKDL80	3TPPKDN40	3TPPKDN80
WHITE	3TPWKDR40	3TPWKDL80	3TPWKDN40	3TPWKDN80
BROWN	3TPBNKDR40	N/A	N/A	N/A
GREY	3TPGYKDR40	N/A	N/A	N/A

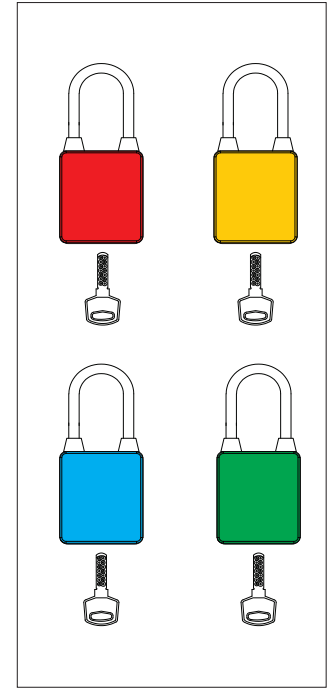

KEYED DIFFERENT + MASTER KEYED

Color	Shackle: SS304 Grade REGULAR: 40mm Height	Shackle: SS304 Grade LONG: 80mm Height	Shackle: Non Conductive REGULAR: 40mm Height	Shackle: Non Conductive LONG: 80mm Height
	MODEL No.	MODEL No.	MODEL No.	MODEL No.
RED	3TPRKDMKR40	3TPRKDMKL80	3TPRKDMKN40	3TPRKDMKN80
YELLOW	3TPYKDMKR40	3TPYKDMKL80	3TPYKDMKN40	3TPYKDMKN80
BLUE	3TPBKDMKR40	3TPBKDMKL80	3TPBKDMKN40	3TPBKDMKN80
GREEN	3TPGKDMKR40	3TPGKDMKL80	3TPGKDMKN40	3TPGKDMKN80
ORANGE	3TPOKDMKR40	3TPOKDMKL80	3TPOKDMKN40	3TPOKDMKN80
NOIR (Black)	3TPNKDMKR40	3TPNKDMKL80	3TPNKDMKN40	3TPNKDMKN80
PURPLE	3TPPKDMKR40	3TPPKDMKL80	3TPPKDMKN40	3TPPKDMKN80
WHITE	3TPWKDMKR40	3TPWKDMKL80	3TPWKDMKN40	3TPWKDMKN80

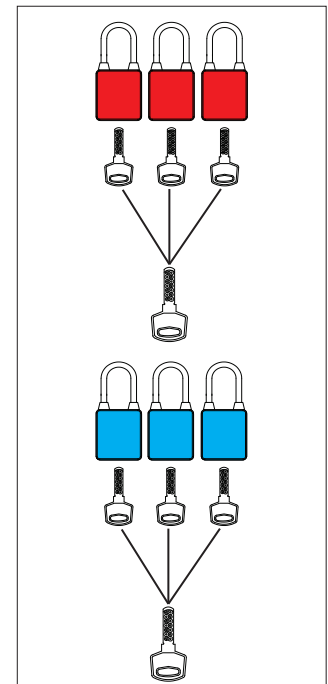

3PTP[®] PADLOCK MODEL NUMBERS

KEYED ALIKE

Color	Shackle: SS304 Grade REGULAR: 40mm Height	Shackle: SS304 Grade LONG: 80mm Height	Shackle: Non Conductive REGULAR: 40mm Height	Shackle: Non Conductive LONG: 80mm Height
	MODEL No.	MODEL No.	MODEL No.	MODEL No.
RED	3PTPRKAR40	3PTPRKAL80	3PTPRKAN40	3PTPRKAN80
YELLOW	3PTPYKAR40	3PTPYKAL80	3PTPYKAN40	3PTPYKAN80
BLUE	3PTPBKAR40	3PTPBKAL80	3PTPBKAN40	3PTPBKAN80
GREEN	3PTPGKAR40	3PTPGKAL80	3PTPGKAN40	3PTPGKAN80
ORANGE	3PTPOKAR40	3PTPOKAL80	3PTPOKAN40	3PTPOKAN80
NOIR (Black)	3PTPNKAR40	3PTPNKAL80	3PTPNKAN40	3PTPNKAN80
PURPLE	3PTPPKAR40	3PTPPKAL80	3PTPPKAN40	3PTPPKAN80
WHITE	3PTPWKAR40	3PTPWKAL80	3PTPWKAN40	3PTPWKAN80

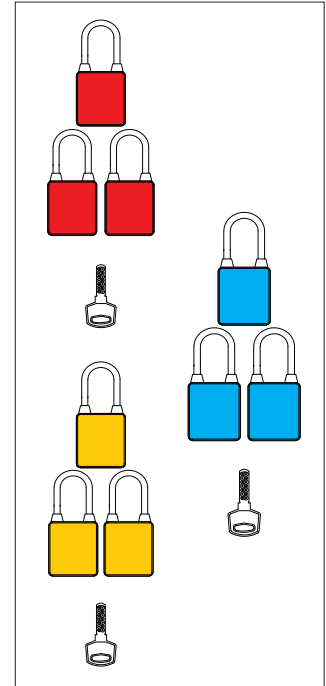

KEYED ALIKE + MASTER KEYED

Color	Shackle: SS304 Grade REGULAR: 40mm Height	Shackle: SS304 Grade LONG: 80mm Height	Shackle: Non Conductive REGULAR: 40mm Height	Shackle: Non Conductive LONG: 80mm Height
	MODEL No.	MODEL No.	MODEL No.	MODEL No.
RED	3PTPRKAMKR40	3PTPRKAMKL80	3PTPRKAMKN40	3PTPRKAMKN80
YELLOW	3PTPYKAMKR40	3PTPYKAMKL80	3PTPYKAMKN40	3PTPYKAMKN80
BLUE	3PTPBKAMKR40	3PTPBKAMKL80	3PTPBKAMKN40	3PTPBKAMKN80
GREEN	3PTPGKAMKR40	3PTPGKAMKL80	3PTPGKAMKN40	3PTPGKAMKN80
ORANGE	3PTPOKAMKR40	3PTPOKAMKL80	3PTPOKAMKN40	3PTPOKAMKN80
NOIR (Black)	3PTPNKAMKR40	3PTPNKAMKL80	3PTPNKAMKN40	3PTPNKAMKN80
PURPLE	3PTPPKAMKR40	3PTPPKAMKL80	3PTPPKAMKN40	3PTPPKAMKN80
WHITE	3PTPWKAMKR40	3PTPWKAMKL80	3PTPWKAMKN40	3PTPWKAMKN80

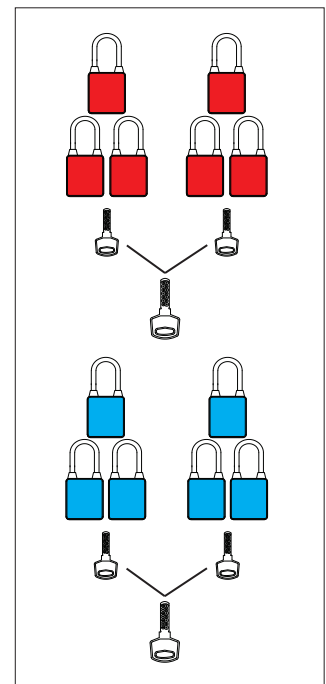

3PTP[®] 3 POINT TRACEABILITY PADLOCK



NEW

GREY



Model No.: 3PTPGYKDR40

BROWN

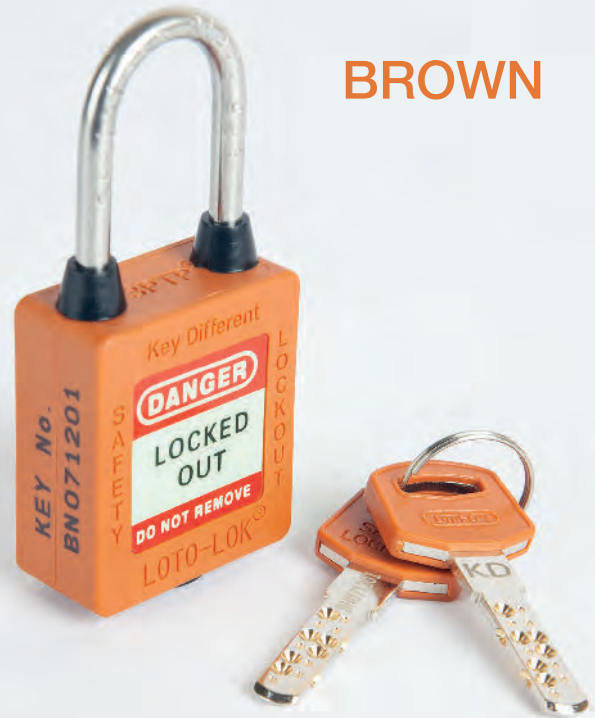

Model No.: 3PTPBNKDR40

**STAINLESS STEEL
(SS304 GRADE)
SHACKLE**

LOTO-LOK[®]

MINI PADLOCKS

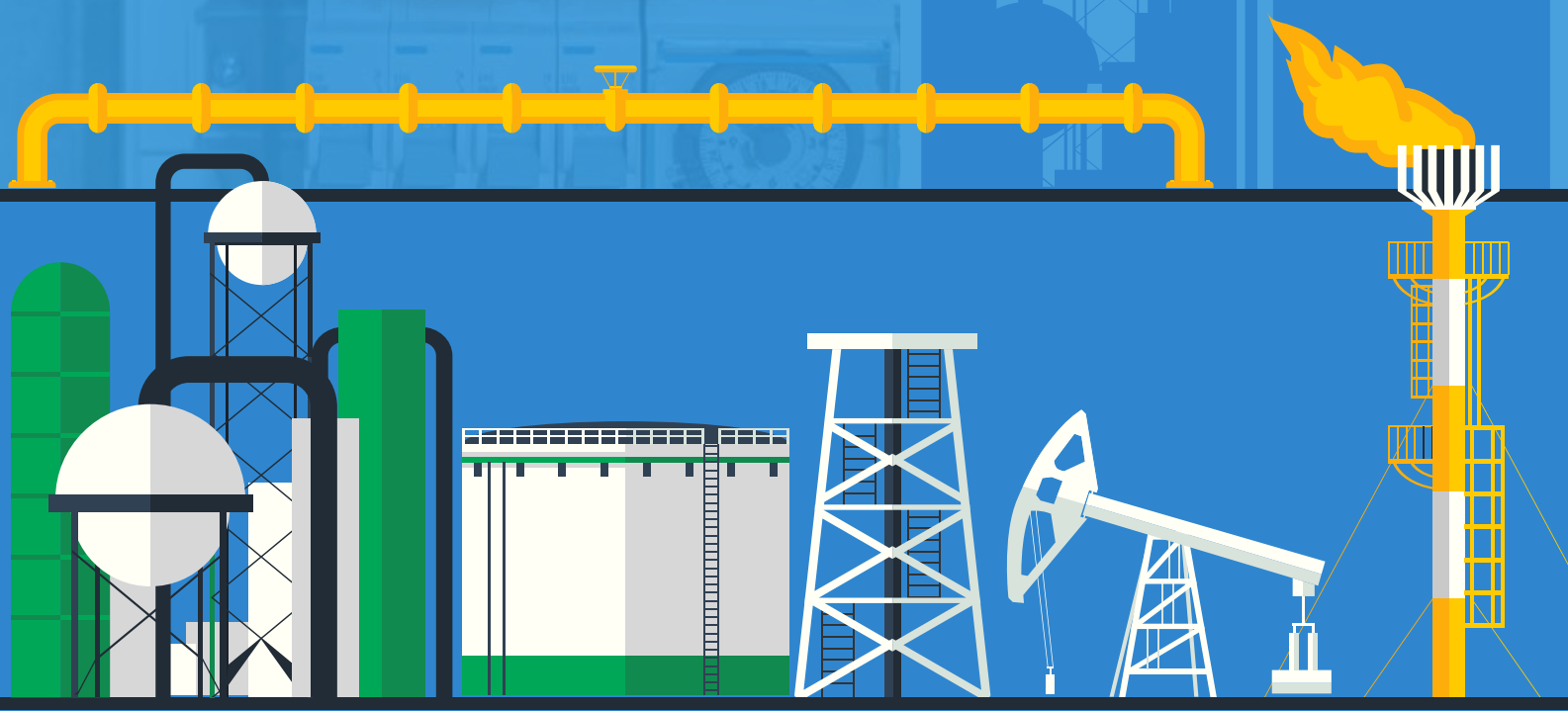

COLOR CODING



KEY SYSTEM



SHACKLE TYPE



Keyed Different Model No.

Color	Stainless Steel	Non-Conductive
RED	PD-MNRD-SSKD	PD-MNRD-NSKD
YELLOW	PD-MNYL-SSKD	PD-MNYL-NSKD
BLUE	PD-MNBL-SSKD	PD-MNBL-NSKD
GREEN	PD-MNGN-SSKD	PD-MNGN-NSKD
ORANGE	PD-MNOR-SSKD	PD-MNOR-NSKD
BLACK	PD-MNBK-SSKD	PD-MNBK-NSKD
PURPLE	PD-MNPR-SSKD	PD-MNPR-NSKD
WHITE	PD-MNWH-SSKD	PD-MNWH-NSKD

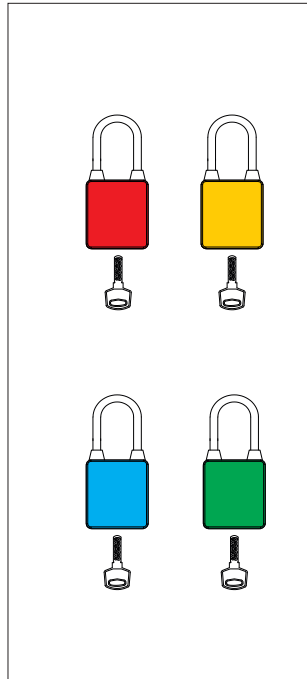

Keyed Different + Master Keyed Model No.

Color	Stainless Steel	Non-Conductive
RED	PD-MNRD-SSKDMK	PD-MNRD-NSKDMK
YELLOW	PD-MNYL-SSKDMK	PD-MNYL-NSKDMK
BLUE	PD-MNBL-SSKDMK	PD-MNBL-NSKDMK
GREEN	PD-MNGN-SSKDMK	PD-MNGN-NSKDMK
ORANGE	PD-MNOR-SSKDMK	PD-MNOR-NSKDMK
BLACK	PD-MNBK-SSKDMK	PD-MNBK-NSKDMK
PURPLE	PD-MNPR-SSKDMK	PD-MNPR-NSKDMK
WHITE	PD-MNWH-SSKDMK	PD-MNWH-NSKDMK

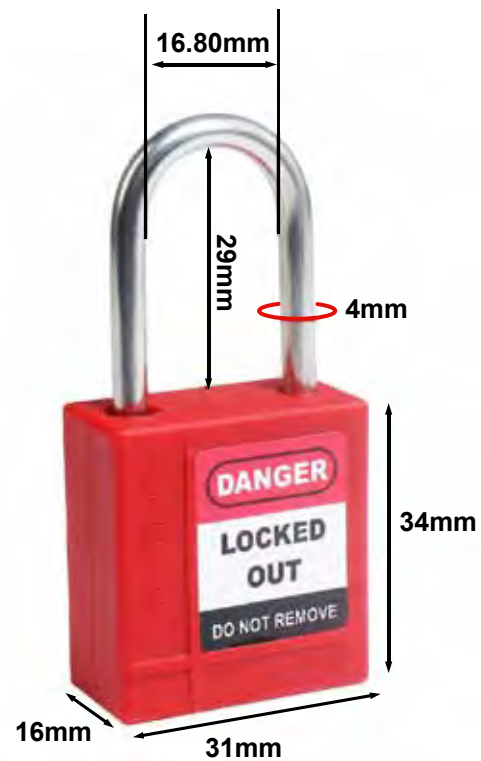
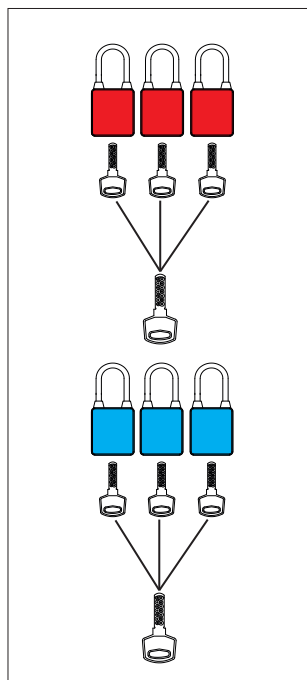

Keyed Alike Model No.		
Color	Stainless Steel	Non-Conductive
RED	PD-MNRD-SSKA	PD-MNRD-NSKA
YELLOW	PD-MNYL-SSKA	PD-MNYL-NSKA
BLUE	PD-MNBL-SSKA	PD-MNBL-NSKA
GREEN	PD-MNGN-SSKA	PD-MNGN-NSKA
ORANGE	PD-MNOR-SSKA	PD-MNOR-NSKA
BLACK	PD-MNBK-SSKA	PD-MNBK-NSKA
PURPLE	PD-MNPR-SSKA	PD-MNPR-NSKA
WHITE	PD-MNWH-SSKA	PD-MNWH-NSKA

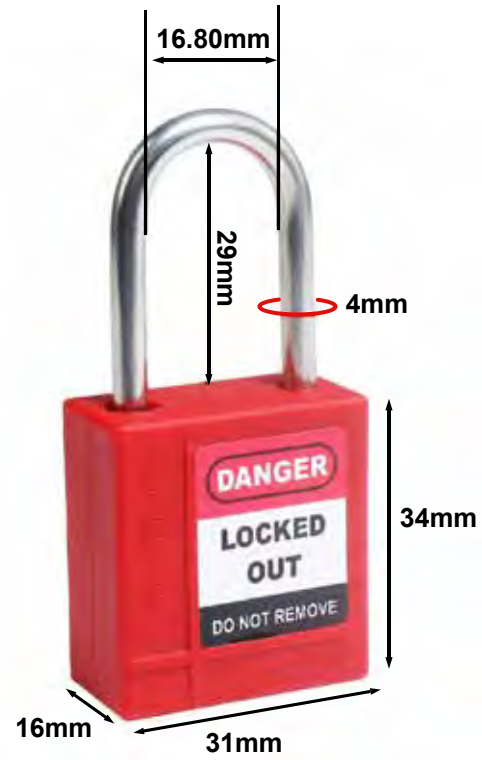
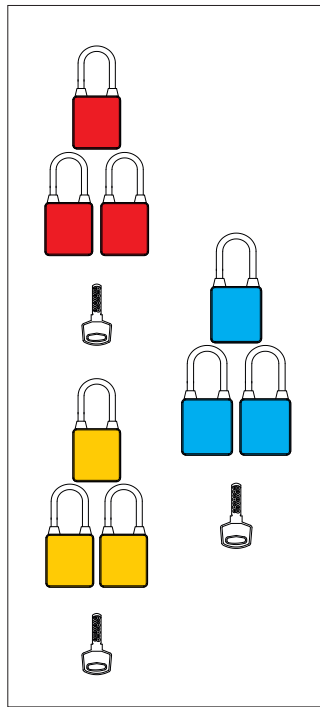

Stainless Steel



Non Conductive



LOQ-IT

ECONOMY LOTO PADLOCKS



LOQ-IT

COMPONENTS AND FEATURES



BODY:

Economy lightweight padlock, durable non-conductive spark proof body made of Nylon PA6, Shock, UV and Chemical resistant, withstands deformation and high ambient temperatures from -20 Deg. C + 177 Deg. C.

CYLINDER:

12 pin zinc cylinder, upto 40000 Keyed Different combinations

COLORS:

Red, Blue, Yellow, Green, Orange, Black, Purple, White, Brown & Grey.

SHACKLE MATERIAL & LENGTH:

Chrome plated steel shackle **OR** Non-Conductive plastic shackle.
Available in 38mm and 76mm shackle lengths.

KEYS:

1 Unique key with every Keyed Different (KD) padlock.

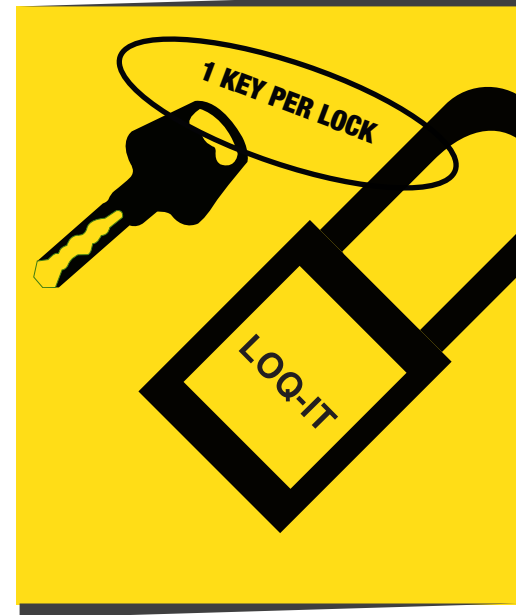

★ Name, Numbers or logo customization available.

★ Key Retaining feature ensures keys cannot be removed until padlocks are closed.

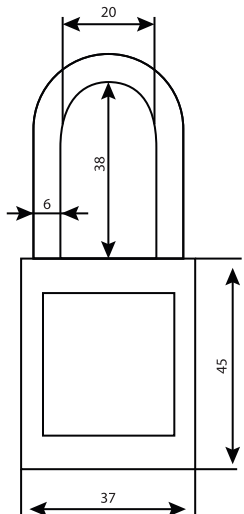

REGULAR SHACKLE DIMENSIONS

Body Width (mm)	37.0mm
Body Thk. (mm)	20.0mm
Body Length (mm)	45.0mm
Total Height (mm)	89.0mm
Shackle Height (mm)	38.0mm
Shackle Dia (mm)	6.0mm

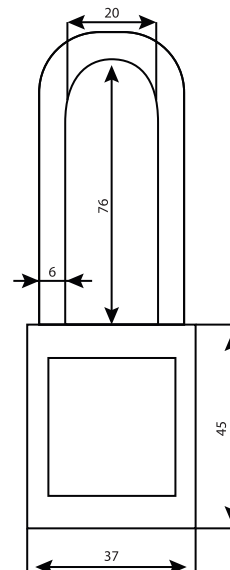

LONG SHACKLE DIMENSIONS

Body Width (mm)	37.0mm
Body Thk. (mm)	20.0mm
Body Length (mm)	45.0mm
Total Height (mm)	126.0mm
Shackle Height (mm)	76.0mm
Shackle Dia (mm)	6.0mm

Meets OSHA 29 CFR 1910.147 regulation for Lockout Tagout

1 key per padlock

10 colors

Competitive price

LOQ-IT ECONOMY PADLOCKS SELECTION GUIDE



Ideal for EPC's, MEP and Contracting companies commissioning large scale projects in the Oil & Gas, Utilities and Industrial sectors where substantial quantities of energy sources need to be locked and tagged prior to handover.



Economy lightweight padlock, durable non-conductive spark proof body made of Nylon PA6, Shock, UV and Chemical resistant, withstands deformation and high ambient temperatures from -20 Deg. C + 177 Deg. C.

COLOR CODING



KEY SYSTEM



SHACKLE TYPE & LGTH

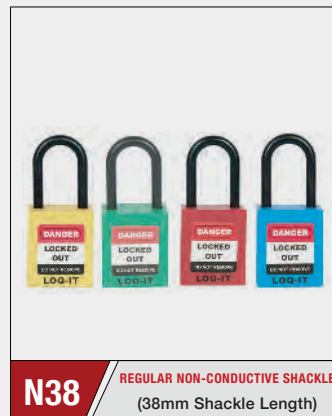
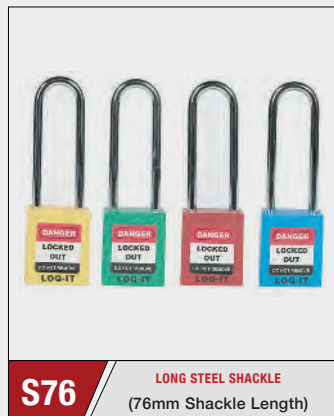
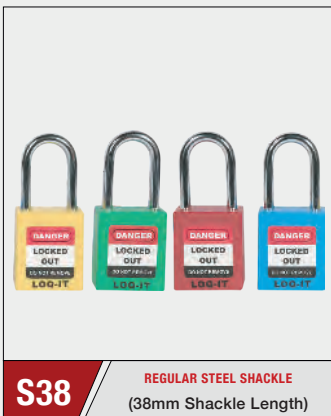
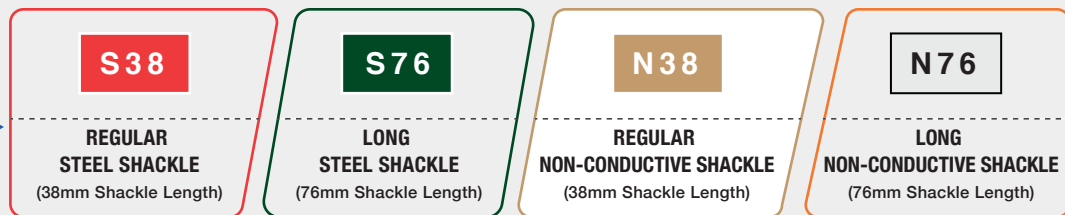

KEYED DIFFERENT - 1 UNIQUE KEY PER PADLOCK

Color	REGULAR STEEL SHACKLE (38mm Shackle Length)	LONG STEEL SHACKLE (76mm Shackle Length)	REGULAR NON-CONDUCTIVE SHACKLE (38mm Shackle Length)	LONG NON-CONDUCTIVE SHACKLE (76mm Shackle Length)
	MODEL No.	MODEL No.	MODEL No.	MODEL No.
RED	PD-LQRDKDS38	PD-LQRDKDS76	PD-LQRDKDN38	PD-LQRDKDN76
YELLOW	PD-LQYLKDS38	PD-LQYLKDS76	PD-LQYLKDN38	PD-LQYLKDN76
BLUE	PD-LQBLKDS38	PD-LQBLKDS76	PD-LQBLKDN38	PD-LQBLKDN76
GREEN	PD-LQGNKDS38	PD-LQGNKDS76	PD-LQGNKDN38	PD-LQGNKDN76
ORANGE	PD-LQORKDS38	PD-LQORKDS76	PD-LQORKDN38	PD-LQORKDN76
BLACK	PD-LQBKDS38	PD-LQBKDS76	PD-LQBKDN38	PD-LQBKDN76
PURPLE	PD-LQPRKDS38	PD-LQPRKDS76	PD-LQPRKDN38	PD-LQPRKDN76
WHITE	PD-LQWHKDS38	PD-LQWHKDS76	PD-LQWHKDN38	PD-LQWHKDN76
BROWN	PD-LQBNKDS38	PD-LQBNKDS76	PD-LQBNKDN38	PD-LQBNKDN76
GREY	PD-LQGYKDS38	PD-LQGYKDS76	PD-LQGYKDN38	PD-LQGYKDN76

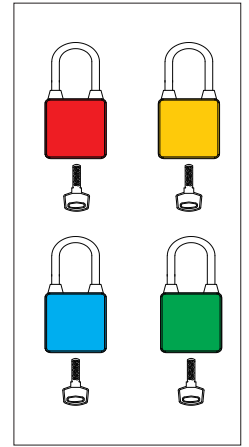

KEYED DIFFERENT (KD) padlocks cannot be master keyed. If key is lost or misplaced, the padlock has to cut/destroyed.

★ Also available in Master Keyed system - customized on request. Minimum quantities and lead time applies.

KEYED ALIKE - 1 KEY PER LOCK

Color	REGULAR STEEL SHACKLE (38mm Shackle Length)	LONG STEEL SHACKLE (76mm Shackle Length)	REGULAR NON-CONDUCTIVE SHACKLE (38mm Shackle Length)	LONG NON-CONDUCTIVE SHACKLE (76mm Shackle Length)
	MODEL No.	MODEL No.	MODEL No.	MODEL No.
RED	PD-LQRDKAS38	PD-LQRDKAS76	PD-LQRDKAN38	PD-LQRDKAN76
YELLOW	PD-LQYLKAS38	PD-LQYLKAS76	PD-LQYLKAN38	PD-LQYLKAN76
BLUE	PD-LQBLKAS38	PD-LQBLKAS76	PD-LQBLKAN38	PD-LQBLKAN76
GREEN	PD-LQGNKAS38	PD-LQGNKAS76	PD-LQGNKAN38	PD-LQGNKAN76
ORANGE	PD-LQORKAS38	PD-LQORKAS76	PD-LQORKAN38	PD-LQORKAN76
BLACK	PD-LQBKAS38	PD-LQBKAS76	PD-LQBKAN38	PD-LQBKAN76
PURPLE	PD-LQPRKAS38	PD-LQPRKAS76	PD-LQPRKAN38	PD-LQPRKAN76
WHITE	PD-LQWHKAS38	PD-LQWHKAS76	PD-LQWHKAN38	PD-LQWHKAN76
BROWN	PD-LQBNKAS38	PD-LQBNKAS76	PD-LQBNKAN38	PD-LQBNKAN76
GREY	PD-LQGYKAS38	PD-LQGYKAS76	PD-LQGYKAN38	PD-LQGYKAN76

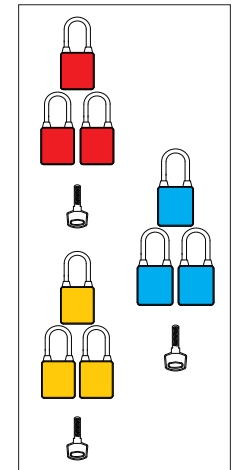

KEYED ALIKE (KA) padlocks can be customized between 2 - 500 pieces in same or different color groups.

LOTO-LOK[®]

ALUMINIUM SAFETY LOCKOUT PADLOCKS

FOOD

PHARMACEUTICALS

OIL & GAS

UTILITIES AND INDUSTRIES

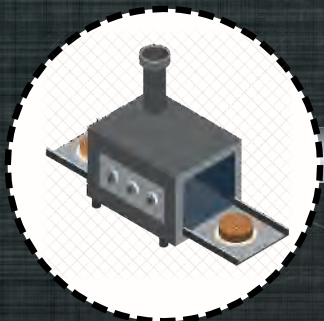

Meets OSHA 29 CFR 1910.147 regulation for Lockout Tagout

2 Keys per padlock

9 Colors

LOTO LOK® ALUMINIUM SAFETY PADLOCKS SELECTION GUIDE

- Aluminium body padlock with SS304 Shackle.
- Ideal for use in Food, Pharmaceuticals, Oil & Gas, Utilities and industries where steam and high temperature furnaces, smelters and boilers applications do not permit the use of plastic padlocks.
- Also suitable for long term outside LOTO in high ambient temperatures and extreme cold where locks made of plastic are incapable of withstanding harsh environmental conditions.
- 2 Keys with each KD (Keyed Different) padlock.
- Key number laser engraved on key & printed on padlock body for easy identification.

COLORS



KEY SYSTEMS



SHACKLE TYPE & LGTH

38

REGULAR
STAINLESS STEEL SHACKLE
(38mm Shackle Length)



38

REGULAR STEEL SHACKLE
(38mm Shackle Length)

76

LONG
STAINLESS STEEL SHACKLE
(76mm Shackle Length)



76

LONG STEEL SHACKLE
(76mm Shackle Length)

DIMENSIONS

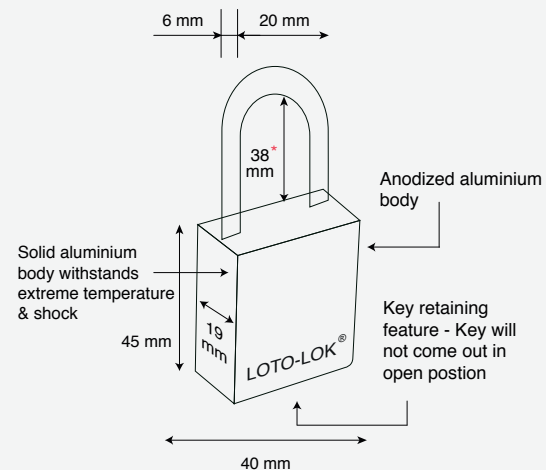

* Long Shackle Padlocks: All dimensions remain the same, except shackle length changes to 76mm

KEYED DIFFERENT

Color	REGULAR STEEL SHACKLE (38mm Shackle Length)	LONG STEEL SHACKLE (76mm Shackle Length)
	MODEL No.	MODEL No.
RED	PD-ALRDKD38	PD-ALRDKD76
YELLOW	PD-ALYLKD38	PD-ALYLKD76
BLUE	PD-ALBLKD38	PD-ALBLKD76
GREEN	PD-ALGNKD38	PD-ALGNKD76
ORANGE	PD-ALORKD38	PD-ALORKD76
BLACK	PD-ALBKKD38	PD-ALBKKD76
PURPLE	PD-ALPRKD38	PD-ALPRKD76
WHITE	PD-ALWHKD38	PD-ALWHKD76
Silver	PD-ALSVKD38	PD-ALSVKD76

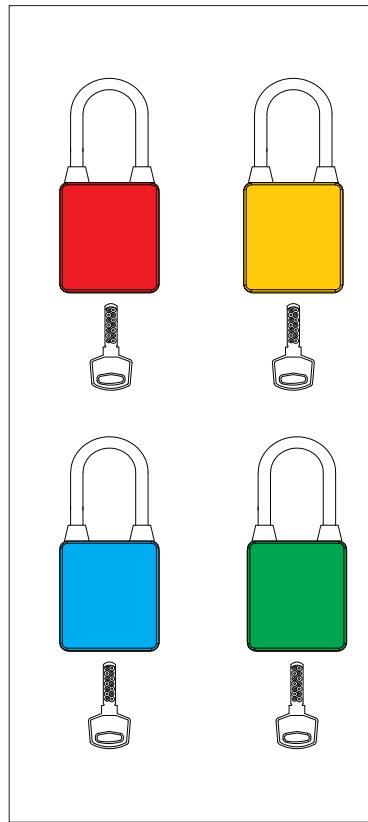

KEYED DIFFERENT (KD) padlocks cannot be master keyed. If key is lost or misplaced, the padlock has to cut/destroyed.

★ Also available in Master Keyed system - customized on request. Minimum quantities and lead time applies.

KEYED ALIKE

Color	REGULAR STEEL SHACKLE (38mm Shackle Length)	LONG STEEL SHACKLE (76mm Shackle Length)
	MODEL No.	MODEL No.
RED	PD-ALRDKA38	PD-ALRDKA76
YELLOW	PD-ALYLKA38	PD-ALYLKA76
BLUE	PD-ALBLKA38	PD-ALBLKA76
GREEN	PD-ALGNKA38	PD-ALGNKA76
ORANGE	PD-ALORKA38	PD-ALORKA76
BLACK	PD-ALBKKA38	PD-ALBKKA76
PURPLE	PD-ALPRKA38	PD-ALPRKA76
WHITE	PD-ALWHKA38	PD-ALWHKA76
Silver	PD-ALSVKA38	PD-ALSVKA76

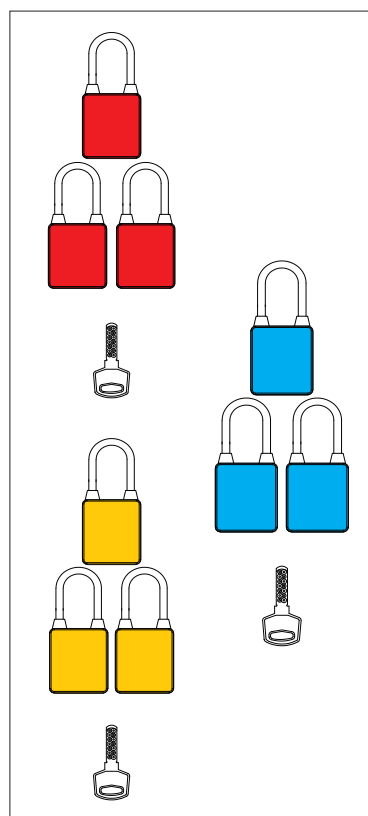

KEYED ALIKE (KA) padlocks can be customized between 2 - 500 pieces in same or different color groups.

LOTO-LOK[®]

CABLE LOCKOUT PADLOCK



Meets OSHA 29 CFR 1910.147 regulation for Lockout Tagout

2 Keys per padlock

8 Colors

LOTO LOK® CABLE LOCKOUT PADLOCK SELECTION GUIDE

KEYED DIFFERENT - 2 KEYS PER LOCK

Color	175 mm Shackle Length
	MODEL No.
RED	WSP-KDR175MM
YELLOW	WSP-KDY175MM
BLUE	WSP-KDB175MM
GREEN	WSP-KDG175MM
ORANGE	WSP-KDO175MM
BLACK	WSP-KDN175MM
PURPLE	WSP-KDP175MM
WHITE	WSP-KDW175MM

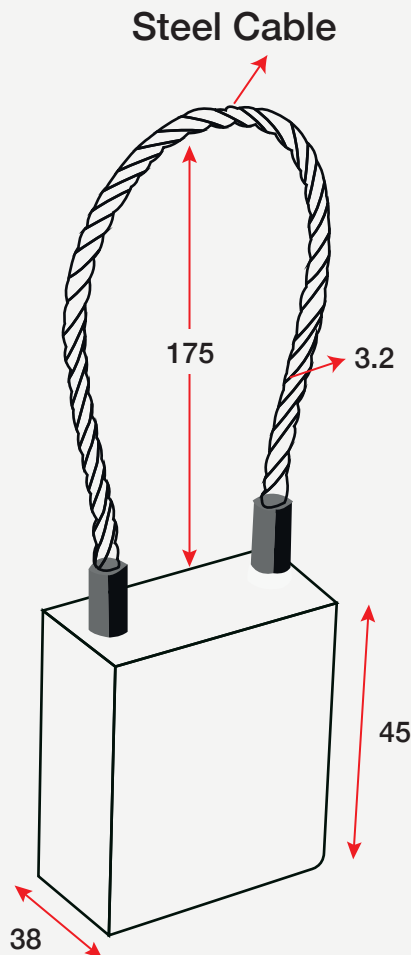

KEYED DIFFERENT (KD) padlocks cannot be master keyed. If key is lost or misplaced, the padlock has to be cut/destroyed.

Body Width : 38.0 mm.
Body Height : 45.0 mm.
Cable Diameter : 3.2 mm.
Cable Length : 175.0 mm.

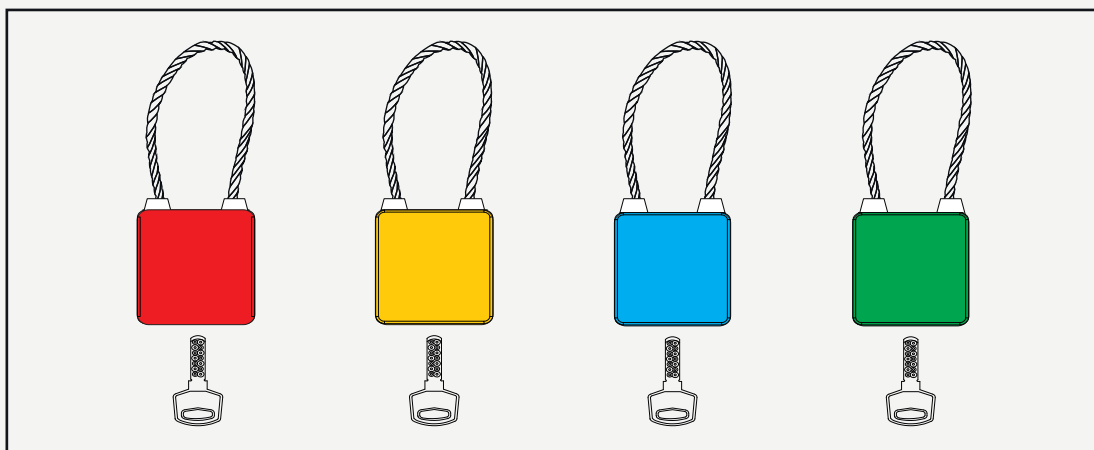

★ Also available in Keyed Alike & Master Keyed system - customized on request. Minimum quantities and lead time applies.



LOTO-LOK[®]

2PTP-STEEL LAMINATED SAFETY LOCKOUT PADLOCKS



2PTP-S PADLOCK FEATURES

1

Tough Steel Laminated Body with chrome plated steel shackles

2

key System & Key nos. laser engraved on padlock body and key permits fast traceability between Padlock & Key, ideal for small or large LO/TO Programs. Additionally, key system is also printed on vinyl sticker for identification initiate appropriate action in the event of lost or misplaced keys.

3

DANGER- DO NOT OPERATE vinyl sticker with printed key System, space for writing owners name and padlock nos. provides clear and visible warning, ideal for LO/TO implementation.

4

Standard 40mm body width comes with 2 Shackle options: 24 and 47mm shackle lengths.

5

Cut resist 6.0mm diameter steel chrome plated shackles.

6

Pick resistant 5 Pin cylinders on all locks.

7

Non-Key Retaining facility.

8

3 Key Systems enables customization of LO/TO Programs to suit different energy sources.

9

Padlocks are fixed with color coded bumpers for customizing different energy sources or team.
Blue, Green, Orange, Black, Purple and White to color code individual or groups of locks to denote energy/team identification.

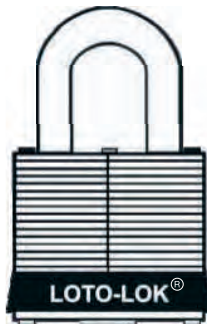

Dimensions:

Body Width (mm)	Body Height (mm)	Body Thick (mm)	Vertical Clearance (mm)	Shackle Dia (mm)	Total Height (mm)
40.00	33.00	22.50	24.00	6.00	64.00

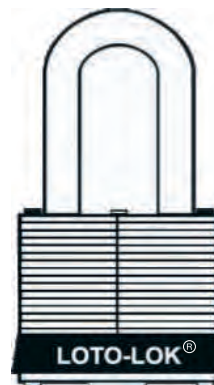

Dimensions:

Body Width (mm)	Body Height (mm)	Body Thick (mm)	Vertical Clearance (mm)	Shackle Dia (mm)	Total Height (mm)
40.00	33.00	22.50	47.00	6.00	86.50

2PTP-S PADLOCK KEY SYSTEM

KEYED DIFFERENT

Each Keyed Different padlock operates with a unique key ensuring the highest security for the end user.

This means all locks have different key combinations, no two keys are the same and each key is unique to that lock and will not open any other lock.

2PTP-STEEL laminated safety padlocks in Keyed Different system come with 2 Unique keys as standard.

Keyed Different padlocks cannot be Master Keyed, locks have to be destroyed if keys are lost or misplaced.



Bumper Color	Shackle: Steel Chrome Plated SHORT: 24mm Height	Shackle: Steel Chrome Plated LONG: 47mm Height
MODEL No.		MODEL No.
RED	2PTPSRKDS24	2PTPSRKDL47
YELLOW	2PTPSYKDS24	2PTPSYKDL47
BLUE	2PTPSBKDS24	2PTPSBKDL47
GREEN	2PTPSGKDS24	2PTPSGKDL47
ORANGE	2PTPSOKDS24	2PTPSOKDL47
NOIR (Black)	2PTPSNKDS24	2PTPSNKDL47
PURPLE	2PTPSPKDS24	2PTPSPKDL47
WHITE	2PTPSWKDS24	2PTPSWKDL47

KEYED ALIKE

Keyed Alike padlocks operate with a common key, one key opens all locks in the same group.

Standard groups consist of between 2 - 100 padlocks per group.

KA padlocks can be customized to several hundreds, each KA group operates with a Different Keyed Alike Key.

2PTP-STEEL padlocks in Keyed Alike system come with 1 Key Alike per lock as standard.

Key codes are not recorded, spare keys if required should be included with order.

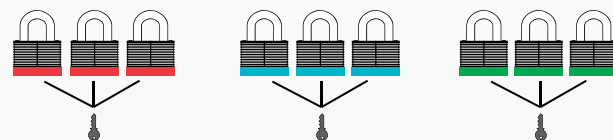

Bumper Color	Shackle: Steel Chrome Plated SHORT: 24mm Height	Shackle: Steel Chrome Plated LONG: 47mm Height
MODEL No.		MODEL No.
RED	2PTPSRKAS24	2PTPSRKAL47
YELLOW	2PTPSYKAS24	2PTPSYKAL47
BLUE	2PTPSBKAS24	2PTPSBKAL47
GREEN	2PTPSGKAS24	2PTPSGKAL47
ORANGE	2PTPSOKAS24	2PTPSOKAL47
NOIR (Black)	2PTPSNKAS24	2PTPSNKAL47
PURPLE	2PTPSPKAS24	2PTPSPKAL47
WHITE	2PTPSWKAS24	2PTPSWKAL47

KEYED DIFFERENT + MASTER KEYED

Each lock in a KD+MK system comes with 2 unique keys per lock and a Master Key opens all locks in a particular batch.

Separately Master Keyed batches can be ordered ranging from 2 - 100 padlocks.

Padlocks over 100 upto 1000 Pcs. per batch operating on a single Master Key can be customized on request.

2PTP-STEEL padlocks in Keyed Different system come with 2 Unique keys as standard. Master Keys are available in 1 or multiples and are ordered separately.

Master Keys available at time of order ONLY as key codes are not recorded.

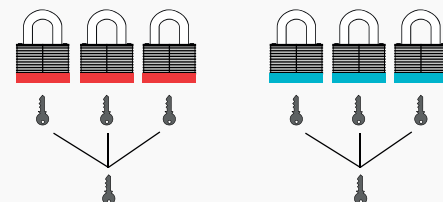

Bumper Color	Shackle: Steel Chrome Plated SHORT: 24mm Height	Shackle: Steel Chrome Plated LONG: 47mm Height
MODEL No.		MODEL No.
RED	2PTPSRKDMKS24	2PTPSRKDMKL47
YELLOW	2PTPSYKDMKS24	2PTPSYKDMKL47
BLUE	2PTPSBKDMKS24	2PTPSBKDMKL47
GREEN	2PTPSGKDMKS24	2PTPSGKDMKL47
ORANGE	2PTPSOKDMKS24	2PTPSOKDMKL47
NOIR (Black)	2PTPSNKDMKS24	2PTPSNKDMKL47
PURPLE	2PTPSPKDMKS24	2PTPSPKDMKL47
WHITE	2PTPSWKDMKS24	2PTPSWKDMKL47

LOTO-LOK[®] is a registered brand name of LOTO Safety Products DMCC, Dubai (UAE).



LOGO is a registered trademark of LOTO Safety Products DMCC, Dubai (UAE).

3PTP[®] is a registered trademark of LOTO Safety Products DMCC, Dubai (UAE).

3PTP (3 Point Traceability Padlock) are protected by patents in USA, UAE, KSA & EU.

USA Patent No. US D702,103 S

USA Patent No. US D115/2012

KSA Patent No. 2964

EU Design Regn. No.002113423-0001

3PTP[®] denotes 3 Point Traceability Padlock.

2PTP-S denotes 2 Point Traceability Padlock-Steel.

Notes:

LOTO logo, LOTO-LOK[®] & 3PTP[®] brand is the property LOTO Safety Products DMCC, Dubai (UAE). Unauthorized use of brand names or trademarks will result in legal action being pursued.

All images and designs in this brochure is the property of LOTO Safety Products DMCC, Dubai (UAE). Written consent is required from LOTO Safety Products DMCC, Dubai (UAE) for use of images for commercial or other purposes.

Disclaimer:

Upgrading product designs and features is continuous process at LOTO Safety Products DMCC. We reserve sole rights to make changes to any product, brochure or literature without prior notice.

LOTO Safety Products DMCC does everything within its control to ensure all its products are free from defects.

It is the obligation of the owner and/or the equipment operator to carefully read and understand the use of LOTO-LOK[®] Safety lockout padlocks and determine the correct selection.

The components of LOTO-LOK[®] Safety Padlocks are selected for optimum function, durability and appearance, LOTO Safety Products DMCC is not responsible for loss of damage caused by their malfunction or part failure, while operating the padlocks.

LOTO Safety Products DMCC is not responsible for damages to persons or property caused by improper use of padlocks. Damages to persons or property caused by failure of LOTO-LOK[®] safety padlocks to the extent that the law permits, any liability which may be incurred as a result of the use of a product manufactured or sold by LOTO Safety Products DMCC is limited to the cost of repairing or replacing the failed product or component at the discretion of LOTO Safety Products DMCC within the warranty period, and does not extend to any loss or damage which may be caused as a consequence of misuse or failure of the products.

LOTO Safety Products DMCC, its owner(s), its shareholder(s), or its agents shall not in any event be liable for economic loss of profits, indirect, special bodily injuries or consequential damages. By virtue of taking possession of any product marketed by LOTO Safety Products DMCC, the owner and/or the equipment operator agree to the terms of this Disclaimer.





LOCKOUT / TAGOUT SAVES LIVES

Is your facility compliant to
OSHA 29 CFR 1910.147 standard?

**LOTO DEVICES, PADLOCKS AND TAGS FOR
ISOLATION OF HAZARDOUS ENERGY**

**CALL OR MAIL
TO CONDUCT LOTO
ASSESSMENTS AT
YOUR FACILITY**



LOTO SAFETY REQUISITES TRADING L.L.C.

Belresheed Warehouse No.7, Next To Jacky's Electronics, Nad Al Hamar, P.O Box 114738, Dubai - UAE

Tel: +971-4-4539779 E-mail: info@lotosafetyproducts.com www.lotosafetyproducts.com

IX

jackets
45 cal
100 cal

trousers
26 cal

shirts
72 cal

coveralls
12 cal

kits
ARC FLASH PPE
earthing kits
insulated matting

insulated gloves

VI



III





index

⚡ ARC FLASH BASICS 01-05

⚡ ARC FLASH PPE	10 CAL	06
	12 CAL	07-14
	26 CAL	15-16
	40 CAL	17-23
	65 CAL	24-26
	100 CAL	27-28
	140 CAL	29-30

⚡ ARC FLASH FACE SHIELDS & HARD HATS 12-13

⚡ ELECTRICAL SAFETY SHOES & BOOTS 32-37

⚡ INSULATED GLOVES & ACCESSORIES 38-41

⚡ VOLTAGE DETECTORS & INSULATED STICKS 42-46

⚡ EARTHING KITS & ALLIED EQUIPMENT 47-49

⚡ ELECTRIC SHOCK RESCUE EQPT & POSTERS 50-56

⚡ INSULATED MATTING, CLIPS & CABLE CUTTER 56-58

⚡ ARC FLASH SUPPRESSION BLANKETS 59

⚡ MEASURING INSTRUMENTS 60-63

⚡ MAGNETIC SIGNS & ACCESSORIES 63-65

1

PPE CATEGORY



MINIMUM ARC RATING OF

4 cal/cm²

Arc Rated Clothing

- ⚡ AR long-sleeve shirt and pants, or AR coverall
- ⚡ AR face shield, or AR flash suit hood
- ⚡ AR jacket, parka, rainwear, or hard hat liner (as needed)

Protective Equipment

- ⚡ Hard hat
- ⚡ Safety glasses or safety goggles
- ⚡ Hearing protection (with inserts)
- ⚡ Heavy-duty leather gloves
- ⚡ Leather footwear (as needed)

2

PPE CATEGORY



MINIMUM ARC RATING OF

8 cal/cm²

Arc Rated Clothing

- ⚡ AR long-sleeve shirt and pants, or AR coverall
- ⚡ AR flash suit hood, or AR face shield and AR balaclava
- ⚡ AR jacket, parka, rainwear, or hard hat liner (as needed)

Protective Equipment

- ⚡ Hard hat
- ⚡ Safety glasses or safety goggles
- ⚡ Hearing protection (with inserts)
- ⚡ Heavy-duty leather gloves
- ⚡ Leather footwear

3

PPE CATEGORY



MINIMUM ARC RATING OF

25 cal/cm²

Arc Rated Clothing

- ⚡ As required: AR long-sleeve shirt, AR pants, AR coverall, AR flash suit jacket, and/or AR flash suit pants
- ⚡ AR flash suit hood
- ⚡ AR gloves
- ⚡ AR jacket, parka, rainwear, or hard hat liner (as needed)

Protective Equipment

- ⚡ Hard hat
- ⚡ Safety glasses or safety goggles
- ⚡ Hearing protection (with inserts)
- ⚡ Leather footwear (as needed)

4

PPE CATEGORY



MINIMUM ARC RATING OF

40 cal/cm²

Arc Rated Clothing

- ⚡ As required: AR long-sleeve shirt, AR pants, AR coverall, AR flash suit jacket, and/or AR flash suit pants
- ⚡ AR flash suit hood
- ⚡ AR gloves
- ⚡ AR jacket, parka, rainwear, or hard hat liner (as needed)

Protective Equipment

- ⚡ Hard hat
- ⚡ Safety glasses or safety goggles
- ⚡ Hearing protection (with inserts)
- ⚡ Leather footwear (as needed)

PRE-JOB BRIEFING CHECKLIST

Identify

- The hazards
- The voltage levels involved
- Skills required
- Any secondary voltage source
- Any unusual work conditions
- Number of people needed to do the job
- The shock protection boundaries
- The available incident energy
- Potential for arc flash (conduct a flash hazard analysis?)
- Flash protection boundary

ASK

- Can equipment be de-energized?
- Are backfeeds on circuits possible?
- Is a "Stand-by person" required?

Check

- Job Plans
- Single-line diagrams and vendor prints
- Status board
- Information on plant and vendor resources
- Safety procedures
- Vendor info
- Individuals are familiar with the facility

Know

- What the job is
- Who else needs to Know - Communicate
- Who is in charge

Think

- About the unexpected event
- Lock – Tag – Try – Test
- Test for voltage before touch
- Use the right tools and equipment/PPE
- Install and remove grounds
- Install barriers and barricades
- What else....?
- What if.....?

Prepare for an emergency

- Are individuals CPR/First Aid trained?
- Emergency equipment provided and available?
- Where is the nearest telephone?
- Where is the fire alarm?
- Is rescue equipment available?
- What is work location?
- Emergency shut-off for equipment?
- Emergency telephone numbers known or posted?
- Where is fire extinguisher?
- Are radio communications available?

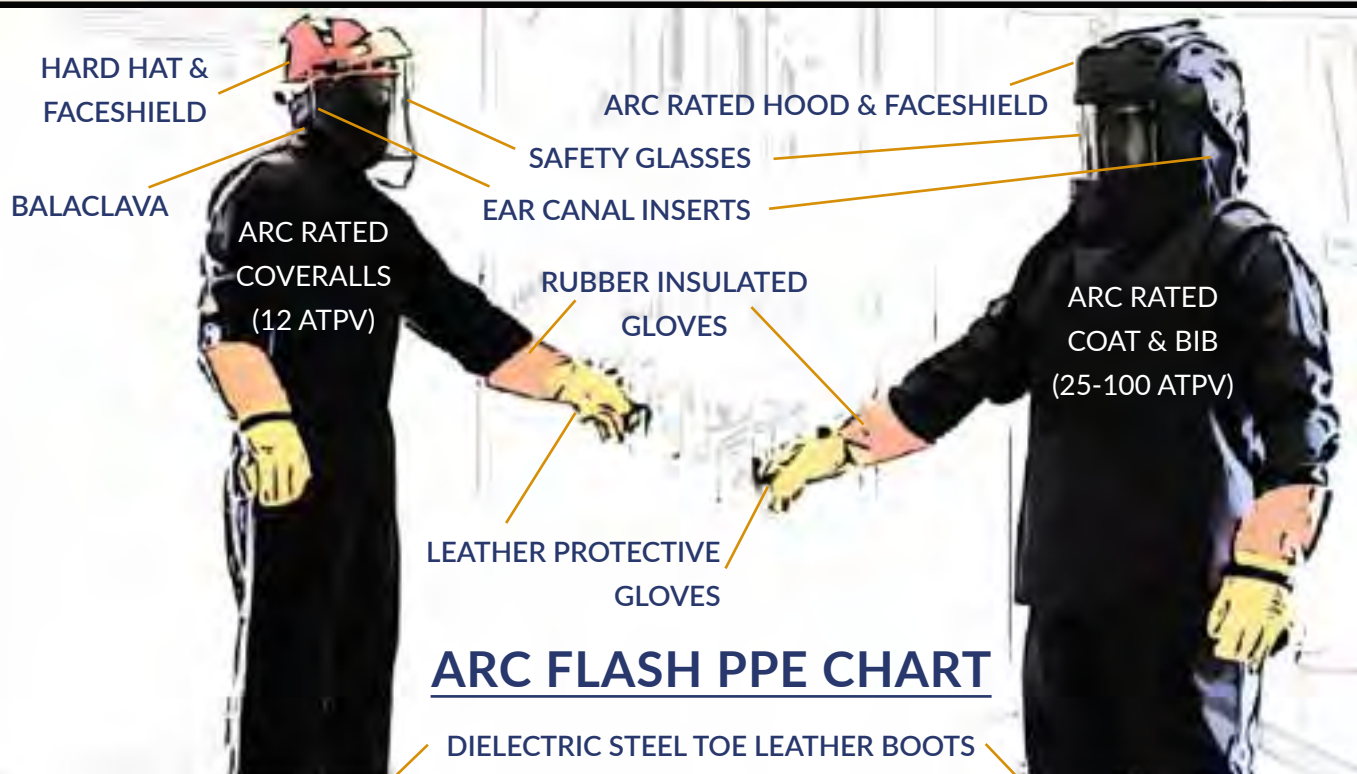

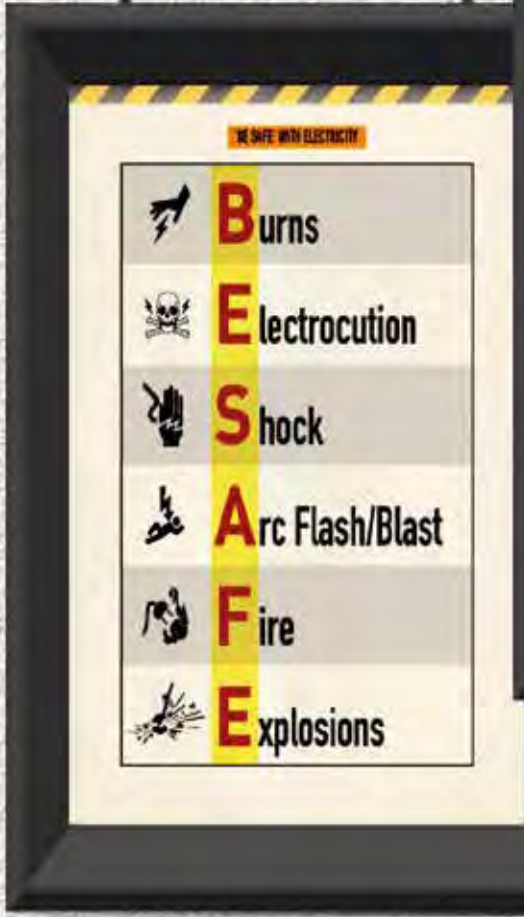

Boundaries for Arc Flash and Shock - Approach Limits

Based on CSA Z462-2015 and NFPA 70E-2015 Standard Editions

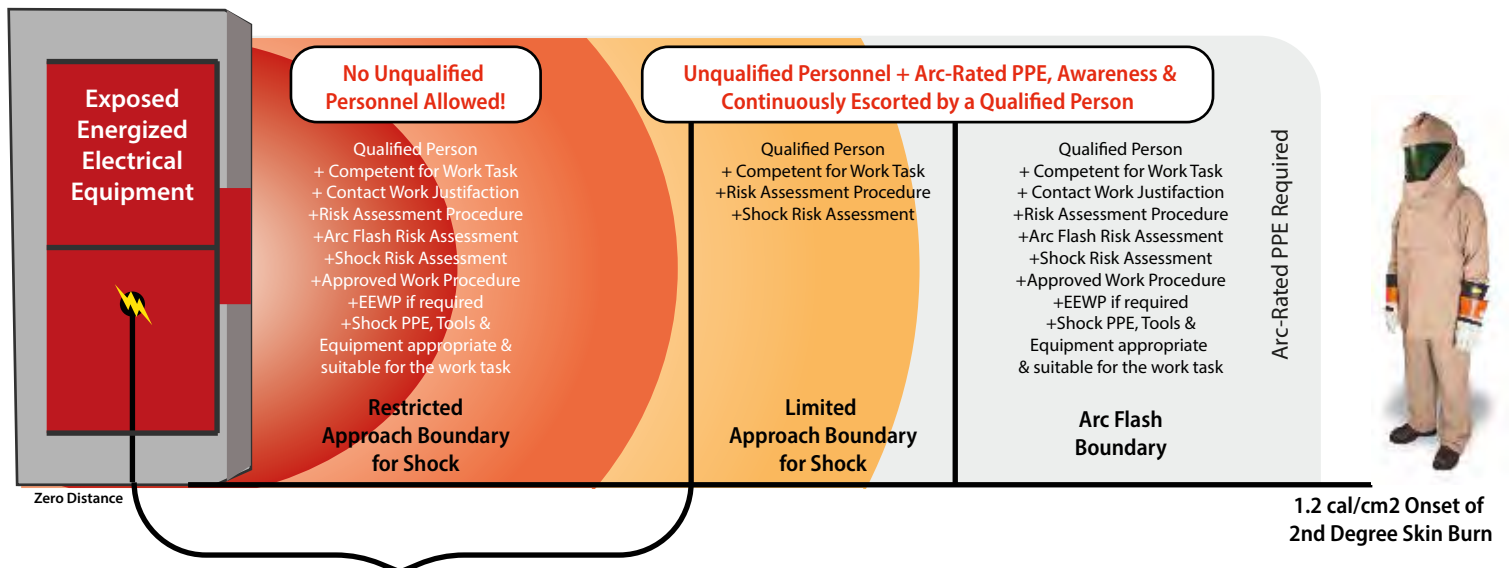

ELECTRICIANS SAFETY FLOW CHART

Does the task involve exposure to energized components with voltage greater than 50 volts?

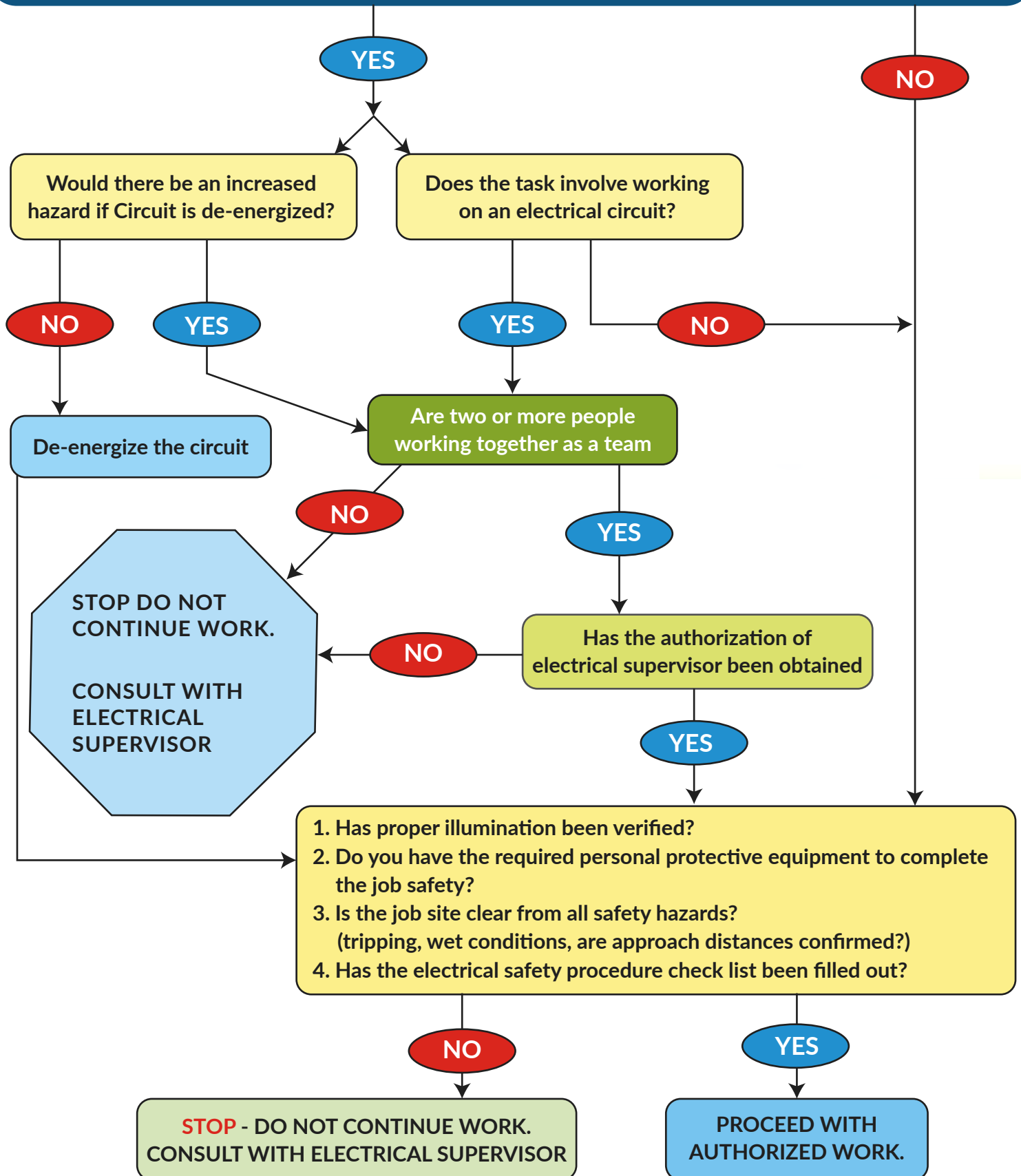

A qualified employee is a person who possesses a recognized degree, certification, or professional standing, or who by expertise, knowledge, training, and experience has successfully demonstrated their ability to resolve problems relating to the work, subject matter, or the project.



ELECTRICIANS SAFETY CHECK LIST

DATE: _____ TIME: _____

EMPLOYEE: _____

DESCRIPTION OF JOB: _____

WORK LOCATION: _____

WORK ORDER OR LOG NUMBER: _____

DATE & TIME SUPERVISOR VISITED JOB SITE FOR SAFETY CHECKS: _____

YES	NO	ITEM TO CONSIDER	PERSONAL PROTECTIVE EQUIPMENT REQUIREMENTS
		<ul style="list-style-type: none"> ➤ I have reviewed this job assignment with my supervisor and have been made aware of possible safety issues and proper procedures to follow. ➤ Do I know and understand the proper procedures to do the job? ➤ Do I have the right PPE and tools for the job I've been assigned? ➤ Have I informed the affected personnel that I will be de-energizing the panel, circuit, and/or equipment and have I relayed the approximate time of the outage? ➤ Is my work environment well lit? ➤ Is my work area free of water, tripping hazards or any other hazards? ➤ If I have identified any safety hazards, have I contacted my supervisor and/or other responsible parties to order to remedy the situation? ➤ If using extension cords or power tools, are the cords free from damage (cracked, cut, or taped)? ➤ Do I feel that I can do the job safely? Have I communicated this with my supervisor? ➤ Will I be alert and not rush the job by reaching blindly into areas containing live parts? ➤ What is the operating voltage? ➤ Are there internal safety mechanisms? ➤ After turning disconnecting means to the "OFF" position, have I checked to see if the conductors are de-energized using the appropriate tester? ➤ During trouble-shooting, if testing equipment in an energized state, have I used the proper PPE equipment and tools for the job? 	<ul style="list-style-type: none"> <input type="checkbox"/> Lockout/Tag Out <input type="checkbox"/> Ground fault protection <input type="checkbox"/> 500 V insulated gloves <input type="checkbox"/> 5 KV gloves <input type="checkbox"/> 15 KV gloves <input type="checkbox"/> Protective sleeves <input type="checkbox"/> Electrical hard hat <input type="checkbox"/> Insulator boots <input type="checkbox"/> Insulator mat <input type="checkbox"/> Insulator blanket <input type="checkbox"/> 1000V rated tools <input type="checkbox"/> Insulator Coat <input type="checkbox"/> Safety harness and tripod <input type="checkbox"/> Force air machine <input type="checkbox"/> Respirator <input type="checkbox"/> Eye or face protection <input type="checkbox"/> Long sleeved shirt <input type="checkbox"/> Ear protection <input type="checkbox"/> Caution tape or barriers <input type="checkbox"/> Hot stick <input type="checkbox"/> Other

Print Name : _____ Print Name : _____
(Employee)
(Supervisor)

Employee Signature : _____ Supervisor Signature : _____

Certified to NFPA 2112 & ASTM F1959 for Arc Flash Protection. Meets Latest NFPA Norms.

ATPV Rating: 10 cal/cm² HRC 2

TARARCTM BLOK-ARCTM Series ARC FLASH COVERALL

Model No: BLOKARC-10COV- __ NV (__ stands for SIZE)

Color: NAVY BLUE ATPV Rating: 10 cal/cm²

Numeric Sizes: 34 - 54. Coveralls are USA/EU sizes

SPECIFICATION:

- Fabric Code: **TaracomfortTM CN240E**
- Fabric Weight: 240 GSM (± 5%)
- 88% Cotton, 12% Nylon
- Weave: 3/1 Twill
- Treated FR - will NOT melt, drip or ignite

38mm FR reflective tape on shoulder, sleeves and legs.



TARARCTM BLOK-ARCTM Series ARC FLASH FEATHERLITE SHIRT



Model No: BLOKARC-10FSH- __ LB (__ stands for SIZE)

Color: LIGHT BLUE ATPV Rating: 10 cal/cm²

Numeric Sizes: Small - 5XL. Shirts are USA/EU sizes.

SPECIFICATION:

- Fabric Code: **TaracomfortTM CN240E**
- Fabric Weight: 240 GSM (± 5%)
- 88% Cotton, 12% Nylon
- Weave: 3/1 Twill
- Treated FR - will NOT melt, drip or ignite

38mm reflective tape on both sleeves.

TARARCTM BLOK-ARCTM Series ARC FLASH FORMAL TROUSER

Model No: BLOKARC-10FTR- __ NV (__ stands for SIZE)

Color: NAVY BLUE ATPV Rating: 10 cal/cm²

Numeric Sizes: 28" - 46". Trousers are USA/EU sizes.

SPECIFICATION:

- Elastic waist adjustment upto 1"
- Fabric Code: **TaracomfortTM CN240E**
- Fabric Weight: 240 GSM (± 5%)
- 88% Cotton, 12% Nylon
- Weave: 3/1 Twill
- Treated FR - will NOT melt, drip or ignite

38mm reflective tape on both legs below knees.



Certified to NFPA 2112 & EN 61482-1-2 for Arc Flash Protection. Meets Latest NFPA & EN Norms.

ATPV Rating: 12 cal/cm² HRC 2

TARARC™ BLOK-ARC™ Series Inherently Flame Retardant MAGNIFICO COVERALL

Model No: BLOKARC-12CV- __ NV (__ stands for SIZE)

Color: NAVY BLUE ATPV Rating: 12 cal/cm²

Numeric Sizes: 34 - 54. Coveralls are USA/EU sizes

SPECIFICATION:

- Fabric Code: **TARAMOD™ MA CINCO 250**
- Fabric Weight: 250gsm (+/- 5%). Weave: Rip Stop
- Fabric Type: Inherently FR Modacrylic and Cellulose blended protective clothing, with outstanding resistance to chemicals and solvents
- Inherently Flame Retardant will NOT melt, drip or ignite



38mm FR reflective tape on shoulder, sleeves and legs.

TARARC™ BLOK-ARC™ Series ARC FLASH FEATHERLITE SHIRT



Model No: BLOKARC-12FSH- __ MB (__ stands for SIZE)

Color: MID BLUE ATPV Rating: 12 cal/cm²

Numeric Sizes: Small - 3XL. Shirts are USA/EU sizes.

SPECIFICATION:

- Fabric Code: **TARAMOD™ MA CINCO 250**
- Fabric Weight: 250 GSM (± 5%)
- Modacrylic Cellulose base Multi Fiber
- Weave: Rip Stop
- Inherently Flame Retardant will NOT melt, drip or ignite

38mm reflective tape on both sleeves.

TARARC™ BLOK-ARC™ Series ARC FLASH JACKET

Model No: BLOKARC-12JKT- __ NV (__ stands for SIZE)

Color: NAVY BLUE ATPV Rating: 12 cal/cm²

Numeric Sizes: Small - 3XL. Jackets are USA/EU sizes

SPECIFICATION:

- Ribbed Cuffs
- Modacrylic Cellulose base Multi Fiber
- Fabric Code: **TARAMOD™ MA CINCO 250**
- Fabric Weight: 250 GSM (± 5%)
- Inherently Flame Retardant will NOT melt, drip or ignite



38mm reflective tape on shoulders & arms.

Certified to NFPA 2112 & EN 61482-1-2 for Arc Flash Protection. Meets Latest NFPA & EN Norms.

ATPV Rating: 12 cal/cm² HRC 2

TARARCTM BLOK-ARCTM Series ARC FLASH CARGO TROUSER

Model No: BLOKARC-12CGTR- __ NV (__ stands for SIZE)

Color: NAVY BLUE ATPV Rating: 12 cal/cm²

Numeric Sizes: 28" - 46". Cargo trousers are USA/EU sizes.

SPECIFICATION:

- 2 Cargo Pockets.
- Elastic waist adjustment upto 1"
- Modacrylic Cellulose base Multi Fiber
- Fabric Code: **TARAMODTM MA CINCO 250**
- Fabric Weight: 250 GSM (± 5%)
- Inherently Flame Retardant will NOT melt, drip or ignite



38mm reflective tape on both legs.

Certified to NFPA 2112 & EN 61482-1-2 for Arc Flash Protection. Meets Latest NFPA & EN Norms.

ATPV Rating: 13 cal / cm² HRC 2

TARARCTM BLOK-ARCTM SERIES ARC FLASH 13 CAL FRESCO POLO T-SHIRT

Model No: BLOKARC-POLO13- NV __ (__ stands for SIZE)

Color: NAVY BLUE ATPV Rating: 13 cal/cm²

Numeric Sizes: Small - 3XL. Fresco Polo T-Shirts are USA/EU sizes.

SPECIFICATION:

- Ribbed Cuffs
- Modacrylic Cellulose base Multi Fiber
- Fabric Code: **TARAKNITSTM MA CINCO 250 IL**
- Fabric Weight: 7.5 Oz. / 250 GSM (± 5%)
- Inherently Flame Retardant will NOT melt, drip or ignite



NOTE: FRESCO POLO T-SHIRT is UNISEX.

Certified to NFPA 2112 & EN 61482-1-2 for Arc Flash protection. Meets Latest NFPA & EN Norms

ATPV Rating: 13 cal/cm² HRC 2

TARARC™ BLOK-ARC™ Series BALACLAVA, TARAMOD MA CINCO 250 IL (FACE OPEN)

Model No: BLOKARC-13BC1-OSFA

Color: NAVY BLUE ATPV Rating: 13 cal/cm²

Brand: TARARC™ (Made in India)

SPECIFICATION:

- One size fits all
- HRC 2 Flame Resistant
- Inherently Flame Retardant will NOT melt, drip or ignite
- Weave: Interlock
- Fabric Weight: 250 GSM (±5%)



TARARC™ BLOK-ARC™ Series BALACLAVA, TARAMOD MA CINCO 250 IL (EYES OPEN)



Model No: BLOKARC-13BC2-OSFA

Color: NAVY BLUE ATPV Rating: 13 cal/cm²

Brand: TARARC™ (Made in India)

SPECIFICATION:

- One size fits all
- HRC 2 Flame Resistant
- Inherently Flame Retardant will NOT melt, drip or ignite
- Weave: Interlock
- Fabric Weight: 250 GSM (±5%)

Certified to NFPA 2112 & EN 61482-1-2 for Arc Flash protection. Meets Latest NFPA & EN Norms

ATPV Rating: 12 cal/cm² HRC 2

12 CAL KIT - COVERALL + FACESHIELD + HARD HAT + BALACLAVA + HOOD BAG + GEAR BAG

Model No: KIT-AF12-TABL-CVFS__ (__ stands for kit size 36-54)

Color: NAVY BLUE ATPV Rating: 12 cal/cm²

Numeric Sizes: 34 - 54. Coveralls are USA/EU sizes

KIT INCLUDES THE FOLLOWING ITEMS:

- 12 CAL **TARARC™** (India) **BLOK-ARC™** Series Inherently Flame Retardant **MAGNIFICO** Coverall
Color: NAVY BLUE ATPV Rating: 12 cal / cm² HRC 2
- 13 CAL **TARARC™** (India) **BLOK-ARC™** Series Balaclava, **TARAMOD MA CINCO 250 IL**
Color: NAVY BLUE. ATPV Rating: 13 cal/cm² HRC 2
- 14 CAL **DELTAPLUS ELVEX® ArcFit** 14 cal Face Shield with Bracket
Faceshield Brand: **DELTAPLUS** with Test Certificate.
Product No: Faceshield (FS20CPARC10). Bracket (VB-60)
Arc Rating 14 cal/cm²
- Safety Helmet with Chin Strap. Class E, 20000 V. (ANSI Z89.1) 440 V a.c. (EN397). Helmet **Brand: Blue Eagle (Taiwan)**
- Hood Bag for Faceshield & Helmet. **Brand: BLOK-ARC™**
- Duffle Tote Electrical / Gear Bag to store Arc Flash Kit with 2 carry handles
Size: 62 x 32 x 37 cm



12 CAL KIT - BIB OVERALL + SHORT COAT + FACESHIELD + HARD HAT + BALACLAVA + HOOD BAG + GEAR BAG

Model No: KIT-AF12-TABL-SBFS__ (__ stands for kit size 36-54)

Color: NAVY BLUE ATPV Rating: 12 cal/cm²

Numeric Sizes: 34 - 54. Bib overalls & Short Coats are USA/EU

KIT INCLUDES THE FOLLOWING ITEMS:

- 12 CAL **TARARC™** (India) **BLOK-ARC™** Series Inherently Flame Retardant **MAGNIFICO** Coverall.
Color: NAVY BLUE. ATPV Rating: 12 cal / cm² HRC 2
- 12 CAL **TARARC™** (India) **BLOK-ARC™** Series Arc Flash 32" Length Short Coat
Color: NAVY BLUE. ATPV Rating: 12 cal / cm² HRC 2
- 13 CAL **TARARC™** (India) **BLOK-ARC™** Series Balaclava, **TARAMOD MA CINCO 250 IL**
Color: NAVY BLUE. ATPV Rating: 13 cal / cm² HRC 2
- 14 CAL **DELTAPLUS ELVEX® ArcFit** 14 cal Face Shield with Bracket.
Faceshield Brand: **DELTAPLUS** with Test Certificate. Product No: Faceshield (FS20CPARC10). Bracket (VB-60). Arc Rating 14 cal/cm²
- Safety Helmet with Chin Strap. Class E, 20000 V. (ANSI Z89.1) 440 V a.c. (EN397). Helmet **Brand: Blue Eagle (Taiwan)**
- Duffle Tote Electrical / Gear Bag to store Arc Flash Kit with 2 carry handles
Size: 62 x 32 x 37 cms



Certified to NFPA 2112 & EN 61482-1-2 for Arc Flash protection. Meets Latest NFPA & EN Norms

ATPV Rating: 12 cal/cm² HRC 2

TARARC™ BLOK-ARC™ Series 12 CAL KIT - BIB OVERALL + SHORT COAT + HOOD + HOOD BAG + GEAR BAG

Model No: KIT-AF12-TABL-SBHD

Color: NAVY BLUE ATPV Rating: 12 cal/cm²

Sizes: Small - 5XL. Bib overalls & Short Coats are USA/EU

KIT INCLUDES THE FOLLOWING ITEMS:

- 12 CAL TARARC™ (India) BLOK-ARC™ Series Arc Flash Bib Overalls.
Color: NAVY BLUE. ATPV Rating: 12 cal / cm² . HRC 2
- 12 CAL TARARC™ (India) BLOK-ARC™ Series Arc Flash 32" Length SHORT COAT
Color: NAVY BLUE. ATPV Rating: 12 cal / cm² . HRC 2
- 12 CAL TARARC™ (India) BLOK-ARC™ Series Arc Flash Hood
Color: NAVY BLUE. ATPV Rating: 12 cal / cm² . HRC 2
- HOOD BAG. **Brand: BLOK-ARC™**
- Duffle Tote Electrical / Gear Bag to store Arc Flash Kit with 2 carry handles.
Size: 62 x 32 x 37 cms

Inherently Flame Retardant will NOT melt, drip or ignite.





NSA (USA) ARC FLASH 12 CAL ARCGUARD KIT COMPOSITION

Certified to NFPA 2112 for Arc Flash protection. Meets latest NFPA norms

NSA (USA) ARCGUARD PROTERA - SHORT COAT + BIB OVERALL + BALACLAVA + HARD HAT + FACE SHIELD + BAG + GEAR BAG

Model No: KIT2SCPR12_ _NG (_ _ stands for Size)

Color: NAVY BLUE ATPV Rating: 12 cal/cm²

Brand: NSA (Made in USA) Sizes: Small - 5XL

Arc Rating: 12 cal / cm², HRC 2 Fabrics: 8 oz. DUPONT PROTERA

KIT INCLUDES THE FOLLOWING ITEMS:

- 12 Cal FR DuPont™ Protera® Short coat, 32" Long
- 12 Cal FR DuPont™ Protera® Bib Overall, 32" inseam
- 12 Cal Arc Flash Faceshield unit + Hard Hat
- Faceshield Bag
- 12 Cal UltraSoft® Knit Hood / Balaclava
- Electrical Gear bag

Inherently Flame Retardant will NOT melt, drip or ignite.



ARC FLASH FACESHIELDS AND HARD HATS

MEETS LATEST NFPA & EN NORMS

DELTAPLUS ELVEX® ARCFIT 14 CAL FACE SHIELD WITH BRACKET

Model No: VISORF14+U
Color: GREY/GREEN.
ATPV Rating: 14 cal/cm²
Brand: DELTAPLUS
Product No: Faceshield (FS20CPARC10). Bracket (VB-60).

FEATURES:

- DELTAPLUS ELVEX® ARCFIT 14 cal new face shield is 12% Lighter Arc Rating 14 cal/cm², 2.5 inches Slimmer Lower Profile Chin Guard and Higher VLT
- Offers Improved Head Mobility with Better Chin Protection Clearance when compared to competitive models
- For Arc Flash Hazards; NFPA 70E PPE Category Protection Levels 1 & 2
- With VB-60 Dielectric cap-attached Visor Bracket



BLUE EAGLE 11 CAL ARC FLASH FACESHIELD

Model No: ARC-FCA8
Color: GREY **Material:** Polycarbonate.
ATPV Rating: 11 cal/cm²
Brand: Blue Eagle **Made in Taiwan**
Sizes: 8" x 19" (20 cm x 48 cm). **Thickness:** 1.5mm.

FEATURES:

- Arc Flash Protection (American Standard) - Certified by ANSI Z87.1 and ASTM F2178 (Standard Test Method for Determining the Arc Rating and Standard Specification for Eye or Face Protective Products)
- Arc Flash Protection (European Standard) - Certified by EN166 and GS-ET-29 (Supplementary requirements for the testing and certification of face shields for electrical works)



ARC FLASH FACESHIELDS AND HARD HATS

BLUE EAGLE ELECTRICAL SHOCK RESISTANT SAFETY HELMET WITH CHIN STRAP

Model No: HR36WH (White) / HR36YE (Yellow)
Color: WHITE (HR36WH) & Yellow (HR36YE).
ATPV Rating: 14 cal/cm²
Brand: BLUE EAGLE Made in Taiwan

FEATURES:

- Material: High Impact resistance ABS
- Class E, 20000 V. (ANSI Z89.1)
- 440 V a.c. (EN397)
- Harness Type: 6-Point Nylon Suspension
- Headband Adjustment: Ratchet
- with CHIN STRAP (M1)



Certified to NFPA 2112 for Arc Flash protection. Meets latest NFPA norms

ATPV Rating: 12 cal/cm² HRC 2

NSA (USA) ARCGUARD® KNIT GLOVES

Model No: G16RG__ (__ stands for Size)

Color: LIGHT GREY ATPV Rating: 12 cal/cm²

Size: Regular (RG) & Large (LG).

Material: 6.5 oz UltraSoft® Rib Knit

Arc Rating: 12 cal / cm², HRC 2

FEATURES:

- Can be used as a liner for voltage gloves for added comfort
- Double layer rib knit cuff
- Stretches to allow for flexibility and dexterity
- FR Fabric will NOT melt, drip or ignite



NOTE: Arc Flash Gloves DO NOT provide insulation from shock/voltage. Arc Flash Gloves are NOT a substitution for Rubber Insulating Gloves or leather protectors.

Certified to NFPA 2112 for Arc Flash protection. Meets latest NFPA norms

NSA (USA) ULTRASOFT® KNIT BALACLAVA

Model No: H11RY

Color: NAVY (NV) ATPV Rating: 12.1 cal/cm²

Material: 6.5 oz UltraSoft®

Arc Rating: 12.1 cal / cm², HRC 2

This single layer hood is durable, lightweight, and designed for comfort and flexibility while on the job. Made from 6 OZ. Khaki UltraSoft®, it provides CAT 2 protection to ensure your safety on the job

FEATURES:

- Designed for comfort and flexibility
- FR Fabric will NOT melt, drip or ignite
- One size fits most



Certified to NFPA 2112 & EN 61482-1-2 for Arc Flash protection. Meets Latest NFPA & EN Norms

ATPV Rating: 26 cal/cm² HRC 3

TARARC™ BLOK-ARC™ Series MAHAN 26 CAL (CAT 3) ARC FLASH KIT

KIT WITHOUT FAN (IN HOOD) *



Model: BLOKARC-MHN26-KTNOF

KIT WITH FAN (IN HOOD) *



Model: BLOKARC-MHN26-KTWF



Model No: BLOKARC-MHN26-KTNOF/WF-XXNV (XX stands for Size)

Color: NAVY BLUE **ATPV Rating:** 26 cal/cm²

Size: Small – 3XL. Bib overalls & Coats are USA/EU sizes

COMPOSITION (BIB OVERALL, COAT & HOOD) INHERENTLY FLAME RETARDANT:

- Fabric Weight: 430 GSM (± 5%)
- Material: 2 Layered Lenzing Viscose Modacrylic Cotton Aramid Multi Fiber Blend
- Inherently Flame Retardant will NOT melt, drip or ignite
- Weave: Rip Stop
- Finish: Durable Flame Retardant

KIT INCLUDES THE FOLLOWING ITEMS:

- A.) 26 Cal MAHAN Bib Overall
- B.) 26 Cal MAHAN 32" Short Coat
- C.) 26 Cal MAHAN HOOD. With / Without VENTILATING Fans * (Specify)
- D.) Hood Bag. Brand: **BLOK-ARC™**
- E.) Duffle Tote Electrical / Gear Bag to store Arc Flash Kit with 2 carry handles. **Size:** 62 x 32 x 37 cms



Certified to NFPA 2112 & EN 61482-1-2 for Arc Flash protection. Meets Latest NFPA & EN Norms

ATPV Rating: 26 cal / cm² HRC 3

TARARC™ BLOK-ARC™ Series MAHAN 26 CAL ARC FLASH FABRIC GLOVES

Model No: GL-ARCMH-26

Color: NAVY BLUE ATPV Rating: 26 cal/cm²

Size: Regular (RG) & Large (LG)

Arc Rating: 26 CAL (HRC 3)

COMPOSITION:

- Fabric Weight: 430 GSM (±5%)
- TARARC 32 DUO Lenzing Viscose Modacrylic Cotton Aramid Multi Fiber Blend
- Weave: Rip Stop
- Finish: Durable Flame Retardant
- Inherently Flame Retardant will NOT melt, drip or ignite



NOTE: Arc Flash Gloves DO NOT provide insulation from shock/voltage. Arc Flash Gloves are NOT a substitution for Rubber Insulating Gloves or leather protectors.



NSA (USA) 25 CAL ARC BALACLAVA

Certified to NFPA 2112 for Arc Flash protection. Meets latest NFPA norms

NSA (USA) ULTRASOFT 25 CAL FR BALACLAVA

Model No: H11RV

Color: NAVY BLUE ATPV Rating: 25 cal/cm²

Brand : NSA (Made in USA).

Material: 10.5 oz Westex® Ultrasoft® Rib

Arc Rating: 25 CAL (CAT 3)

COMPOSITION:

- Single Layer UltraSoft®
- Durable and midweight fabric
- Flat lock seam for comfort when worn under a hard hat
- Inherently flame resistant, FR protection will not wash/wear out
- FR fabric will not melt . drip or ignite
- Designed for comfort and flexibility
- One size fits most



Certified to NFPA 2112 & EN 61482-1-2 for Arc Flash protection. Meets Latest NFPA & EN Norms

ATPV Rating: 45 cal / cm² HRC 4

TARARC™ BLOK-ARC™ Series VALLUM 45 CAL ARC FLASH KIT

KIT WITHOUT FAN (IN HOOD) *

KIT WITH FAN (IN HOOD) *



Model: BLOKARC-VLM45-KTNOF

Model: BLOKARC-VLM45-KTWF



Model No: BLOKARC-VLM45-KTNOF/WF-XXNV (XX stands for Size)

Color: NAVY BLUE **ATPV Rating:** 45 cal/cm²

Size: Small – 3XL. Bib overalls & Coats are USA/EU sizes

COMPOSITION (BIB OVERALL, COAT & HOOD) INHERENTLY FLAME RETARDANT:

- Fabric Weight: 470 GSM (± 5%)
- Material: 3 Layered Modacrylic Aramid Multi Fiber Blend
- Inherently Flame Retardant will NOT melt, drip or ignite
- Weave: Rip Stop
- Finish: Durable Flame Retardant

KIT INCLUDES THE FOLLOWING ITEMS:

- A.) 45 Cal Vallum Bib Overall
- B.) 45 Cal Vallum 32" Short Coat
- C.) 45 Cal Vallum Hood. With / Without VENTILATING Fans * (Specify)
- D.) Hood Bag. Brand: **BLOK-ARC™**
- E.) Duffle Tote Electrical / Gear Bag to store Arc Flash Kit with 2 carry handles. Size: 62 x 32 x 37 cms



Standards: ASTM F1506, OSHA 29 CFR 1910.269, NFPA 70E-2015 for Arc Flash, CSA Z462-15 for Arc Flash (Canada).

ATPV Rating: 40 cal/cm² HRC 4

NSA (USA) 40 CAL ARCGUARD REVOLITE ARC FLASH KIT

KIT WITHOUT FANS (IN HOOD) *



Model: KIT4SCLT40NG_ _

KIT WITH FANS (IN HOOD) *



Model: KIT4SCLT40NG_ _CV



40 CAL ARCGUARD REVOLITE ARC FLASH KITS (50% lighter than cotton based systems)
Lightweight Level 4 Arc Flash Protection

Model No: KIT4SCLT40NG_ _ (_ _ stands for Size)

Color: OLIVE GREEN **ATPV Rating: 40 cal/cm²**

Size: Small - 3XL (Excluding Insulated / Arc Thermographer Gloves).

Material: ArcGuard® RevoLite™

INCLUDES THE FOLLOWING ITEMS PER KIT:

- Short Coat, Arc Rating 40 Cal/cm² CAT 4 (C04NPQHLLTD32)
- Bib Overall, Arc Rating 40 Cal/cm² CAT4 (C45NPQHLLT32)
- Hood With / Without VENTILATING Fans and Hood Bag * (Specify)
Faceshield and Hard Hat, Arc Rating 40 cal/cm² CAT 4
- Duffle Tote Electrical / Gear Bag to store Arc Flash Kit with 2 carry handles. Size: 62 x 32 x 37 cms



Agenda

- Performance
- Design
- Standards & Compliance
- Housekeeping



The Comfort Science

THE FIRST SINGLE LAYER 40 CAL SYSTEM

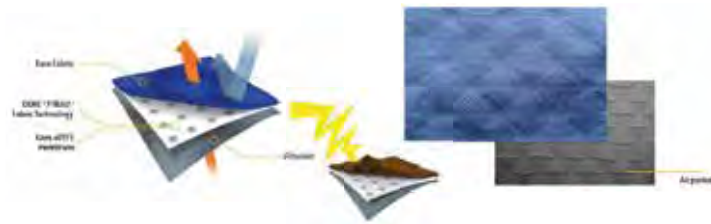

The Comfort Science



20%
LIGHTER

As a fabric system, this product is up to 20% lighter than competitive premium products and more than 50% lighter than a competitive entry level product

The Comfort Science

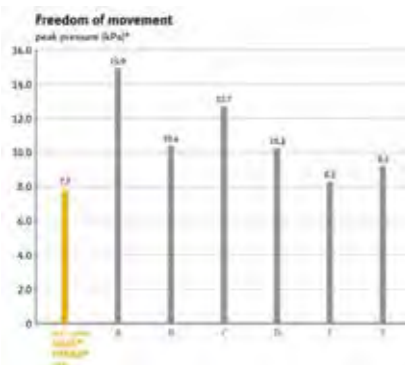



39%
MORE FLEXIBLE

ArcGuard Performance 40 cal is up to 39% more flexible than other competitive premium solutions. The wearer feels an increased ease of motion with less muscular fatigue during the task (e.g. winding, repeatedly removing racks)

Defining Comfort

Based on feedback from end users the top 3 qualities of a comfortable garment:

-  **Lightweight:** Doesn't weight you down
-  **Breathable:** Allows heat & air to flow through
-  **Moisture Wicking:** Pulls moisture away from the body

The Comfort Science

FEATURING PREMIUM BREATHABILITY

Breathability lets perspiration through the fabric system and keeps the wearer comfortable while working on highly physical tasks. As a fabric system, the new GORE® PYRAD® rates as very breathable per the R^{ET} Hohenstein Rating System.



The Comfort Science

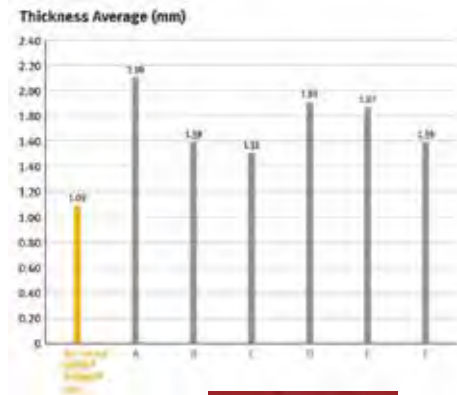

48%
THINNER

The new 40 cal single layer system is up to 48% thinner than competitive premium solutions which allows for thin and highly functional garment design



Standards: NFPA 70E, ASTM F1506, ASTM F2178, ASTM 1959, ANSI Z87.1

ATPV Rating: 42 cal/cm² HRC 4

OBERON (USA) 42 CAL LAN™ ARC FLASH KIT

KIT WITHOUT FAN (IN HOOD) *



Model: LNS4B-__

KIT WITH FAN (IN HOOD) *



Model: LNS4B-__+HVS



SUIT IS MADE OF INHERENTLY FLAME RESISTANT MODACRYLIC BLEND FABRIC

Model No: LNS4B-__ (__ stands for Size) / LNS4B-__+HVS (__ stands for Size)

Color: NAVY BLUE **ATPV Rating:** 42 cal/cm²

Size: Small - 3XL (Excluding Insulated / Arc Thermographer Gloves)

Brand: OBERON (Made in USA)



INCLUDES THE FOLLOWING ITEMS PER KIT:

- LAN40™ Series Arc rating of 42 cal/cm² Deluxe Arc Flash Coats
- LAN40™ Series Arc rating of 42 cal/cm² Arc Flash Bib Overalls
- LAN40™ Series Arc rating of 42 cal/cm² Deluxe Lightweight Arc Flash Hood with Oberon Hard Cap and Polycarbonate NEW True Color Grey Window
- Fresh Air Arc Flash Hood Ventilation System. Pocket mounted system works with LAN Series hoods. Color: Blue. One Size. With / Without VENTILATING Fan * (Specify)
- Duffel Tote Electrical / Gear Bag to store Arc Flash Kit with 2 carry handles Size: 62 x 32 x 37 cms

Standards: NFPA 70E, ASTM F1506, ASTM F2178, ASTM 1959, ANSI Z87.1

Arc Rating 40 cal/cm² - PPE 4

OBERON (USA) 40 CAL TCG™ ARC FLASH KIT (HOOD, COAT, AND BIB OVERALL) SUIT SET

KIT WITHOUT FAN (IN HOOD) *



Model: TCG4B-__

KIT WITH FAN (IN HOOD) *



Model: TCG4B-__ +HVS



ARC FLASH SUIT MADE FROM A DURABLE AND LIGHTWEIGHT ARAMID FABRIC

Model No: TCG4B-__ (__ stands for Size). / TCG4B-__ +HVS (__ stands for Size)

Color: BLACK ATPV Rating: 46 cal/cm²
Size: Small - 3XL (Excluding Insulated / Arc Thermographer Gloves).
Brand: OBERON (Made in USA)

- Meets ANSI /ISEA 125 Level 2 Conformity and Arc Flash PPE Category 4 standards with an arc rating of 46 cal/cm².
- Hoods utilize a patented True Color Grey (TCG™) arc flash face shield technology which produces no color distortion while performing common work tasks and comes with a scratch-resistant, anti-fog coating.
- Arc flash suit set comes equipped with a hood, coat, and bib overalls that are made from a durable and lightweight Aramid fabric.
- Fresh Air Arc Flash Hood Ventilation System. Pocket mounted system works with TCG Series hoods. Color: Blue. One Size.

INCLUDES THE FOLLOWING ITEMS PER KIT:

- 40 Cal TCG™ Arc Flash Coats.
- 40 Cal TCG™ Arc Flash Bib Overalls.
- 40 Cal TCG™ Arc Flash Hood with Window and Hard Cap. With / Without VENTILATING Fan. * (Specify)
- Duffle Tote Electrical / Gear Bag to store Arc Flash Kit with 2 carry handles. Size: 62 x 32 x 37 cms



Standards: NFPA 70E, ASTM F1506, ASTM F2178, ASTM 1959, ANSI Z87.1

Arc Rating 40 cal/cm² - PPE 4

OBERON (USA) 40 CAL CAT™ ARC FLASH HOOD, COATS, AND BIB OVERALLS SUIT SET

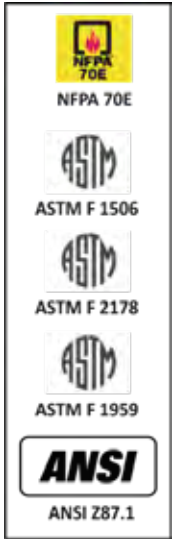

Model No: FRTC4B-__ (__ stands for Size)

Color: KHAKI ATPV Rating: 41 cal/cm²

Size: Small - 3XL (Excluding Insulated / Arc Thermographer Gloves)

Brand: OBERON (Made in USA)



- Meets ANSI /ISEA 125 Level 2 Conformity and Arc Flash PPE Category 4 standards with an arc rating of 41 cal/cm².

- Hoods utilize a patented True Color Grey (TCG™) arc flash face shield technology which produces no color distortion while performing common work tasks and come with a scratch-resistant, anti-fog coating

- Arc flash suit set comes equipped with a flame resistant treated cotton hood, coats, and Bib overall

INCLUDES THE FOLLOWING ITEMS PER KIT:

- 40 Cal TCG™ Arc Flash Coat
- 40 Cal TCG™ Arc Flash Bib Overall
- 40 Cal CAT™ Arc Flash Hood. This hood comes equipped with a Hard Cap and is made with a fire resistant blend of treated Cotton. One Size.
- Duffel Tote Electrical / Gear Bag to store Arc Flash Kit with 2 carry handles. Size: 62 x 32 x 37 cms

ARC FLASH 40 CAL (HRC 4) RATED FABRIC GLOVES - VARIOUS



TARARC™ BLOK-ARC™ SERIES VALLUM 45 CAL ARC FLASH GLOVES



Model No: GL-ARCVL-45
 Color: NAVY BLUE
 ATPV Rating: 45 cal/cm². HRC 4

COMPOSITION:

- Fabric Weight: 470 GSM (± 5%)
- Composition: TARARC 40 + TRIO Modacrylic Aramid Multi Fiber Blend
- Weave: Rip Stop
- Finish Durable Flame Retardant



NOTE: Arc Flash Gloves DO NOT provide insulation from shock/voltage. Arc Flash Gloves are NOT a substitution for Rubber Insulating Gloves or leather protectors.



NSA (USA) THERMOGRAPHER 40 CAL ARC FLASH GLOVES

Model No: G99GGUW__MA40 (__stands for Size)
 Color: GREY
 ATPV Rating: 40 cal/cm²
 Sizes: Large (LG) & XL

COMPOSITION:

- Shell: 9 oz. Ultra Soft
- Liner: 13 oz. Ultra Soft
- Mid Arm length
- Fiber Content: 88% FR Cotton / 12% High Tenacity Nylon
- Finish Durable Flame Retardant



NOTE: Arc Flash Gloves DO NOT provide insulation from shock/voltage. Arc Flash Gloves are NOT a substitution for Rubber Insulating Gloves or leather protectors.



OBERON (USA) 40 CAL TCG™ ARC FLASH GLOVES

Model No: TCG40-GLOVE__(_-stand for size)
 Color: BLACK.
 ATPV Rating: 46 cal/cm². HRC 4
 Sizes: Large(LG) & XL

COMPOSITION:

- Meets ANSI/ISA 125 Level 2 Conformity and Arc Flash PPE Category 4 standards with an arc rating of 46 cal/cm²
- Arc Flash gloves are Made from a lightweight and durable Aramid fabric and are the perfect solution for the thermographers or any electrical worker that needs arc flash protection for their hands



NOTE: Arc Flash Gloves DO NOT provide insulation from shock/voltage. Arc Flash Gloves are NOT a substitution for Rubber Insulating Gloves or leather protectors.

Standards: NFPA 70E, ASTM F1506, ASTM F2178, ASTM 1959, ANSI Z87.1

Arc Rating 65 cal/cm² - CAT 4

NSA (USA) 65 CAL ARC FLASH (HOOD, COAT, AND BIB OVERALL) ARCGUARD KIT COMPOSITION

KIT WITHOUT VENTILATING FANS *



Model: KIT4SC65NG__

KIT WITH VENTILATING FANS *



Model: KIT4SC65NG__



Model No: KIT4SC65NG__ (__ stands for SIZE).

- Color:** BROWN **ATPV Rating:** 65 cal/cm²
- Size:** Small - 3XL (EXCLUDING Insulated / Arc Thermographer Gloves)
- Brand:** NSA (Made in USA)
- Material:** DuPont™ Nomex®/Kevlar®

INCLUDES THE FOLLOWING ITEMS PER KIT:

- 65 Cal Arcguard Nomex/kevlar Arc Flash Coat
- 65 Cal Arcguard Nomex/kevlar Bib Overall
- 65 Cal Arcguard Nomex/kevlar Arc Flash Hood With / Without Ventilating Fans * (Specify)
- Faceshield Unit Bag
- Duffle Tote Electrical / Gear Bag to store Arc Flash Kit with 2 carry handles Size: 62 x 32 x 37 cms

FEATURES:

- FR hook and loop front closure on short coat
- Stand up collar for extra coverage
- Garments embroidered with arc rating
- Quick disconnect and adjustable shoulder straps on bib overalls
- Expandable leg opening to fit over boots



Standards: NFPA 70E, ASTM F1506, ASTM F2178, ASTM 1959, ANSI Z87.1

Arc Rating 76 cal/cm² - PPE 4

OBERON (USA) 65 CAL TCG™ (HOOD, COAT, AND BIB OVERALL) ARC FLASH KITS

KIT WITHOUT VENTILATING FANS *

KIT WITH VENTILATING FANS *



Model: TCG5B-__

Model: TCG5B-__ +HVS

Model No: TCG5B-__ (__ stands for Size) / TCG5B-__ +HVS (__ stands for Size)

Color: BLACK ATPV Rating: 76 cal/cm²

Size: Small - 3XL (EXCLUDING Insulated / Arc Thermographer Gloves)

Brand: OBERON (Made in USA)



PRODUCT DETAILS:

- Suit is made of Inherently Flame Resistant Aramid Fabric
- Fabric Color: Black with HIVEIS Tape
- Arc flash suit set comes equipped with a hood, coat, and bib overalls that are made from a durable and lightweight Aramid fabric

INCLUDES THE FOLLOWING ITEMS PER KIT:

- TCG65™ Series Arc Rating of 76 cal/ cm² Arc Flash Coats
- TCG65™ Series Arc Rating of 76 cal/ cm² Arc Flash Bib Overalls
- TCG65™ Series Arc Rating of 76 cal/ cm² Arc Flash Hood with Oberon Hard Cap and Polycarbonate NEW True Color Grey Window. With / Without VENTILATING Fans * (Specify)
- Duffel Tote Electrical / Gear Bag to store Arc Flash Kit with 2 carry handles Size: 62 x 32 x 37 cms

ARC FLASH 65 CAL RATED FABRIC GLOVES

Standards: NFPA 70E, ASTM F1506, ASTM F2178, ASTM 1959, ANSI Z87.1

NSA (USA) 65 CAL ARCGUARD NOMEX/KEVLAR GLOVES

Model No: G51KDQT14
Color: BROWN
ATPV Rating: 65 cal/cm² - CAT 4
Brand: NSA (Made in USA)

FEATURES:

- Fabric/Material: Multilayer DuPont™ Nomex® and Kevlar®
- Size: 18" Length
- Inherently flame resistant for FR protection that will not wash out
- FR Fabric will not melt, drip or ignite



Note: ONE SIZE ONLY.

NOTE: Arc Flash Gloves DO NOT provide insulation from shock/voltage. Arc Flash Gloves are NOT a substitution for Rubber Insulating Gloves or leather protectors.

OBERON (USA) 65 Cal TCG™ ARC FLASH GLOVES

Model No: TCG65-GLOVE-__ (__ stands for Size)
Color: BLACK
ATPV Rating: 76 cal/cm² - CAT 4
Brand: OBERON (Made in USA)
Sizes: LARGE (LGE) & X-LARGE (XL)
Please confirm sizes required.

FEATURES:

- Arc flash gloves are made from a lightweight and durable Aramid fabric and are the perfect solution for thermographers or any electrical worker that needs arc flash protection for their hands



NOTE: Arc Flash Gloves DO NOT provide insulation from shock/voltage. Arc Flash Gloves are NOT a substitution for Rubber Insulating Gloves or leather protectors.

Standards: NFPA 70E, ASTM F1506, ASTM F2178, ASTM 1959, ANSI Z87.1

Arc Rating 100 cal/cm² - CAT 4

NSA (USA) 100 CAL ARCGUARD ARC FLASH KITS



Model No: KIT4SC100NG__ (__ stands for SIZE)

Color: BROWN

Size: Small - 3XL (EXCLUDING Insulated / Arc Thermographer Gloves).

Brand: NSA (Made in USA)

Material: DuPont™ Nomex®/Kevlar®



INCLUDES THE FOLLOWING ITEMS PER KIT:

- 100 Cal Arcguard Nomex/kevlar Arc Flash Coats
- 100 Cal Arcguard Nomex/kevlar Bib Overalls
- 100 Cal Arcguard Nomex/kevlar Arc Flash Hood With 2 Ventilating Fans
- Faceshield Unit Bag
- Duffle Tote Electrical / Gear Bag to store Arc Flash Kit with 2 carry handles. Size: 62 x 32 x 37 cms

FEATURES:

- FR hook and loop front closure on short coat
- Stand up collar for extra coverage
- Rib knit cuffs for comfortable, secure fit
- Garments embroidered with arc rating
- Quick disconnect and adjustable shoulder straps on bib overalls
- Side slant pockets on bib overalls
- Expandable leg opening to fit over boots
- Hook and loop at side of bib for easy access

ARC FLASH 100 CAL RATED FABRIC GLOVE

Standards: NFPA 70E, ASTM F1506, ASTM F2178, ASTM 1959, ANSI Z87.1

NSA (USA) 100 CAL ARCGUARD NOMEX/KEVLAR GLOVES

Model No: G51KDQE18
Color:
ATPV Rating: 100 cal/cm²
Brand: NSA (Made in USA)
Size: 18" Length
Fabric/Material: Multilayer DuPont Nomex and Kevlar

FEATURES:

- Wide bell cuff
- Inherently flame resistant for FR protection that will not wash out
- FR fabric will not melt, drip or ignite
- Lined with needle punched Dupont™ Nomex® felt



NOTE: Arc Flash Gloves DO NOT provide insulation from shock/voltage. Arc Flash Gloves are NOT a substitution for Rubber Insulating Gloves or leather protectors.



ARC FLASH 100 CAL TCG™ KIT COMPOSITION

OBERON (USA) 100 CAL TCG™ ARC FLASH (HOOD, COAT, AND BIB OVERALL) SUIT SET

Model No: TCG6B-__+HVS (__ stand for SIZE)
Color: BLACK
ATPV Rating: 100 cal/cm², CAT 4
Brand: OBERON (Made in USA)
Sizes: SMALL - 3XL (EXCLUDING Insulated / Arc Thermographer Gloves).
Please confirm sizes required

INCLUDES THE FOLLOWING ITEMS PER KIT:

- TCG100™ Series Ultra Light Weight Arc Flash Coats
- TCG100™ Series Ultra Light Weight Arc Flash Bib Overalls
- TCG100™ Series Ultra Light Weight Arc Flash Hood with Oberon Hard Cap Polycarbonate NEW True Color Grey Window
- Fresh Air Arc Flash Hood Ventilation System. Pocket mounted system works with TCG Series hoods. Color: Blue. One Size. (With Ventilating Fans)
- Duffle Tote Electrical / Gear Bag to store Arc Flash Kit with 2 carry handles
 Size: 62 x 32 x 37 cms



Suit is made from Inherently Flame Resistant Aramid Fabric.



ARC FLASH 100 CAL TCG™ ARC FLASH GLOVE

Standards: NFPA 70E, ASTM F1506, ASTM F2178, ASTM 1959, ANSI Z87.1

OBERON (USA) 100 CAL ARCGUARD NOMEX/KEVLAR GLOVES

Model No: TCG100-GLOVE-__ (__ stands for Size)

Color: BLACK.

ATPV Rating: 100 cal/cm²

Brand: OBERON (Made in USA)

FEATURES:

- Arc flash gloves are made from a lightweight and durable Aramid fabric and are the perfect solution for thermographers or any electrical worker that needs arc flash protection for their hands



NOTE: Arc Flash Gloves DO NOT provide insulation from shock/voltage. Arc Flash Gloves are NOT a substitution for Rubber Insulating Gloves or leather protectors.



ARC FLASH 140 CAL TCG™ KIT COMPOSITION

OBERON (USA) 140 CAL TCG™ ARC FLASH (HOOD, COAT, AND BIB OVERALL) SUIT SET

Model No: TCG7B-__ +HVS (__ stands for Size)

Color: BLACK

ATPV Rating: 140 cal/cm² **Fabric Weight:** 30 oz

Brand: OBERON (Made in USA).

Sizes: SMALL - 3XL (EXCLUDING Insulated / Arc Thermographer Gloves).

Please confirm sizes required

INCLUDES THE FOLLOWING ITEMS PER KIT:

- 140 Cal TCG™ Ultra Light Weight Arc Flash Coats
- 140 Cal TCG™ Ultra Light Weight Arc Flash Bib Overalls
- 140 Cal TCG™ Arc Flash Hood with Oberon Hard Cap Window
- Fresh Air Arc Flash Hood Ventilation System. Pocket mounted system works with TCG Series hoods. Color: Blue. One Size. (With Ventilating Fan)
- Duffle Tote Electrical / Gear Bag to store Arc Flash Kit with 2 carry handles
Size: 62 x 32 x 37 cms
- * **Hood Mounted L.E.D. Light is not included in the offer and quoted separately**



Suit is made from Inherently Flame Resistant Aramid Fabric.

Standards: NFPA 70E, ASTM F1506, ASTM F2178, ASTM 1959, ANSI Z87.1

OBERON (USA) 140 CAL TCG™ ARC FLASH MITTENS GLOVES

Model No: TCG140B-M3F-___ (__ stands for Size)

Color: BLACK.

ATPV Rating: 140 cal/cm²

Brand: OBERON (Made in USA)

Sizes: Regular (REG) & LARGE (LGE)

FEATURES:

- Arc flash gloves are made from a lightweight and durable Aramid fabric and are the perfect solution for thermographers or any electrical worker that needs arc flash protection for their hands
- Meets ANSI /ISEA 125 Level 2 Conformity and Arc Flash PPE Category 4+ standards with an arc rating of 140 cal/cm²



NOTE: Arc Flash Gloves DO NOT provide insulation from shock/voltage. Arc Flash Gloves are NOT a substitution for Rubber Insulating Gloves or leather protectors.

OBERON (USA) FRESH AIR ARC FLASH HOOD VENTILATION SYSTEM

Model No: HVS-4B-PM
Color: BLUE.
Brand: OBERON (Made in USA)

FEATURES:

- Pocket mounted system works with LAN™ ARC™ and TCG Series hoods
- Ventilation system takes 4 AA batteries included with fan
- One Size



NOTE: The fan is quoted separately and can be added to the hood. It is the customers choice to add the fan to the **OBERON brand** Hood Only.

OBERON (USA) HOOD MOUNTED L.E.D. LIGHT

Model No: +LAMP
Color: GREY/GREEN.
Brand: OBERON (Made in USA)

FEATURES:

- Hood light easily clips onto the front of any LAN or TCG Series hoods
Light can be adjusted to point in whatever direction is needed
- Provides 70 Lumens of light and 146 hours of burn time



NOTE: LED lamp is quoted as an extra accessory and can be ordered if required.
This lamp will fit on the **OBERON brand** Hood Only.

MELLOW WALK ELECTRICAL SHOCK RESISTANT SAFETY SHOES (LOW ANKLE)

Model No: QUENTIN 570049 LACE
Color: BLACK
Brand: MELLOW WALK (Made in Canada)

FEATURES:

- MEN'S 6-HOLE LACE, Upper: Leather. Width: 3E (WIDE)
- Lining: Drilex. Fit: Built on comfort-ortho last. Accommodates Orthotics
- Outsole Material: Dual Density PU. ESR 18000V, CSA certified
- Toe Cap: Grade 1 Metal Toe, 100 JOULES
- Footbed: Removable Dreamfit Ultra - Comfort
- Low Ankle with PU Sole
- Construction: Cement / Lock Stitched Sole

Quentin - SIZE	European - SIZE
7	39
7.5	40
8	41
9	42
8.5	42.5
9.5	43
10	44
10.5	44.5
11	45
12	46
13	47
14	48



MELLOW WALK ELECTRICAL SHOCK RESISTANT SAFETY SHOES (LOW ANKLE)

Model No: QUENTIN 550049 SLIP ON
Color: BLACK
Brand: MELLOW WALK (Made in Canada)

FEATURES:

- MEN'S LOAFER, Upper Leather. Width: 3E (WIDE)
- Lining: Drilex
- Fit: Built on comfort-ortho last. Accommodates Orthotics
- Outsole Material: Dual Density PU. ESR 18000V, CSA certified
- Toe Cap: Grade 1 Metal Toe, 100 JOULES
- Footbed: Removable Dreamfit Ultra - Comfort
- Low Ankle with PU Sole
- Construction: Cement / Lock Stitched Sole



Slip Test Rating: Slip tested to CSA Z195-14 / ISO 13287. Standard: ASTM F2413-11 1/75 C/75 PR EH

MELLOW WALK ELECTRICAL SHOCK RESISTANT SAFETY SHOES (LOW ANKLE)

Model No: QUENTIN 542128 METAL FREE
Color: BLACK
Brand: MELLOW WALK (Made in Canada)

FEATURES:

- MEN'S METAL-FREE DUO Upper: Black Leather. Width: 2E (WIDE)
- Lining: Drilex. Fit: Built on comfort-ortho last. Accommodates Orthotics
- Outsole Material: Dual Density PU. ESR 18000V, CSA certified
- Toe Cap: Grade 1 Metal Free Toe, 100 JOULES
- Footbed: Removable Dreamfit Ultra - Comfort
- Low Ankle with PU Sole
- Construction: Cement / Lock Stitched Sole



Slip Test Rating: Slip tested to CSA Z195-14 / ISO 13287. Standard: ASTM F2413-11 1/75 C/75 PR EH

MELLOW WALK ELECTRICAL SHOCK RESISTANT SAFETY SHOES (HIGH ANKLE)

Model No: PATRICK 2.0 515209
Color: BROWN / BLACK
Brand: MELLOW WALK (Made in Canada)

FEATURES:

- Upper: Leather. Width: EE (MEDIUM TO WIDE)
- Fit: Built on extra-depth last. Accommodates Orthotics
- Lining: Gusseted Tongue, High Abrasion Toe Bumper
- Outsole Material: Dual Density Rubber ESR 18000V, CSA certified
- Toe Cap: Grade 1 Metal Toe, 100 JOULES
- Footbed: Removable Dreamfit Ultra - Comfort
- High Ankle with Rubber Sole
- Construction: Cement / Lock Stitched Sole



Slip Test Rating: Slip tested to CSA Z195-14 / ISO 13287. Standard: ASTM F2413-11 1/75 C/75 PR EH

MELLOW WALK ELECTRICAL SHOCK RESISTANT SAFETY SHOES (LOW ANKLE)

Model No: MADDY 481049
Color: BLACK
Brand: MELLOW WALK (Made in Canada).

FEATURES:

- Women's Slip-On. Leather Upper: SPORTY
- Width / Fit: E / Ladies last comfort-ortho fit
- Lining: Blue Onsteam
- Outsole is ESR 18000V, CSA certified
- Toe Cap: Steel toe 100 JOULES
- Footbed: Removable Dreamfit Comfort PU
- Construction: Cement / Stitched



Slip Test Rating: Slip tested to CSA Z195-14 / ISO 13287. Standard: ASTM F2413-11 1/75 C/75 PR EH

MELLOW WALK STATIC DISSIPATIVE SAFETY SHOES (LOW ANKLE)

Model No: DAISY 420092
Color: BLACK
Brand: MELLOW WALK (Made in Canada)

FEATURES:

- Women's Sneaker. THE SUEDE
- Width: E (wide). Upper: Leather & Suede.
- Fit: Built on a Womens' Last
- Lining: Drilex
- Outsole Material: Dual Density PU
- Toe Cap: Steel toe 100 JOULES
- Footbed: Removable Dreamfit Anti-Static
- Construction: Cement / Lock Stitched sole





**mellow
walk**

ELECTRICAL SAFETY SHOES (MEN)

Slip Test Rating: Slip tested to CSA Z195-14 / ISO 13287. Standard: ASTM F2413-11 1/75 C/75 PR EH

MELLOW WALK ELECTRICAL SHOCK RESISTANT SAFETY SHOES (LOW ANKLE)

Model No: PATRICK 517209
Color: GREY
Brand: MELLOW WALK (Made in Canada)

FEATURES:

- ALBERTA. Men's Sneaker (THE GREY KICKS)
- MEN'S 6-HOLE LACE, Upper: Leather. Width: 2E (WIDE)
- Fit: Built on extra-depth last
- Accommodates orthotics
- Lining: Drilex or Onsteam
- Outsole Material: Dual Density PU/Rubber
- Toe Cap: Steel toe 100 JOULES
- Footbed: Removable Dreamfit Ultra-Comfort
- Construction: Cement / Lock Stitched sole



Slip Test Rating: Slip tested to CSA Z195-14 / ISO 13287. Standard: ASTM F2413-11 1/75 C/75 PR EH

MELLOW WALK ELECTRICAL SHOCK RESISTANT SAFETY MEN'S ZIPPER BOOT

Model No: QUENTIN 547049
Color: BLACK
Brand: MELLOW WALK (Made in Canada)

FEATURES:

- Men's Zipper Boot. Upper: Leather. Width: 3E (WIDE)
- Fit: Built on comfort-ortho last
- Accommodates orthotics
- Lining: Drilex.
- Outsole Material: Dual Density PU
- Toe Cap: Steel Toe 100 JOULES
- Footbed: Removable Dreamfit
- Ultra Comfort. Construction: Cement / Lock Stitched Sole



RESPIREX DIELECTRIC BOOTS, 20KV PROTECTION FOR OVER EIGHT HOURS

An electrically insulating dielectric boot with an integral steel toe cap and vulcanized rubber sole for superior slip resistance.

The Respirex Dielectric boot provides protection of up to **20kV** over the complete boot for over 8 hours, and **35kV** over the sole for 3 minutes.



20kV
Protection
For Over Eight
Hours



BOOT SHAFT

- Yellow dielectric compound shaft
- 200 Joule Epoxy coated Steel toe cap to EN ISO 20345
- Comfort insole (removable and machine washable)
- REACH Compliant

BOOT SOLE

- Blue vulcanized rubber sole for maximum grip - 30% better than a conventional safety boot sole
- Slip resistance performance twice that required by EN 13287 SRA and SATRA TM144 standards
- Resistance to hot contact 60 seconds 300°C.
- Energy absorbing tunnel system conforms to EN 20345 E
- Cold insulation to EN ISO 20345

CARE

- Machine washable at up to 40°C
- Shelf life of over 10 years

ELECTRICAL PROTECTION

Complete boot: 20 kV8 hours no damage
 5 kV<5mA Leakage current
 Sole: 35 kV3 minutes no damage

CERTIFICATION

Safety Footwear	EN ISO 20345 I E HRO SRA CI
Electrically Insulating Footwear	EN 50321 Class 0
Dielectric Footwear	ASTM F1117
Personal Protective Equipment	PPE DIR 89/686/EEC

SIZES:

UK	3	4	5	6	7	8	9	10	11	12	13	14	15
EU	35	36	37	39	41	42	43	44	45	46	47	49	50
US	4	5	6	7	8	9	10	11	12	13	14	15	16



Vulcanized Rubber Sole

RESPIREX DIELECTRIC BOOTS, 20KV PROTECTION FOR OVER EIGHT HOURS

An electrically insulating dielectric overboot approved to current European standards with a vulcanized rubber sole for superior slip resistance. The Respirex dielectric boot provides protection of up to 20kV over the complete boot for over three minutes.



17 kV
Maximum Working Voltage

BOOT SHAFT

- Ingenious rear entry design ensures the boot is quick and easy to fit and remove
- Ideal for personnel who have to continually enter and exit hazardous areas
- Kick off lug
- REACH Compliant

BOOT SOLE

- Blue vulcanized rubber sole for maximum grip - 30% better than a conventional safety boot sole
- Slip resistance performance twice that required by EN 13287 SRA and SATRA TM144 standards
- Two to three times the wear resistance of conventional soles
- Fuel and oil resistant
- Greater cut resistance than conventional soles
- Resistance to hot contact 60 seconds 300°C.

CARE

- Machine washable at up to 40°C
- Shelf life of over 10 years

ELECTRICAL PROTECTION

Complete boot: 20 kV3 Minutes, no damage
5 kVLess than 5mA Leakage current

CERTIFICATION

Safety Footwear	EN ISO 20347:2012 - I HRO SRA FO
Electrically Insulating Footwear	EN 50321:1999 Class 0 pr EN 50321:2013 Class 1
Dielectric Footwear	ASTM F1117
Personal Protective Equipment	PPE DIR 89/686/EEC

SIZES

	Medium	Large	Extra-Large
UK	6 - 8	9 - 11	12 - 14
EU	39 - 42	43 - 45	46 - 49
US	7 - 9	10 - 12	13 - 15



Standard: Certified to EN 60903:2003

DPL LINEPRO INSULATED LINESMEN GLOVES

PRODUCT TYPE: ELECTRICIAN - CLASS 00. LENGTH: 360MM

Model No:	GLV-RDSC-CL00
Sizes:	8, 9 & 10
Origin:	Sri Lanka, Manufactured & Certified to EN 60903:2003 Standard.
Product Type:	Electrician - CLASS 00 LENGTH: 360mm
Thickness* (mm):	EN 60903 - 1.10mm (Max)
Maximum Working Voltage AC (V):	500V
Proof Test Voltage AC (V):	2,500V
Withstand Test Voltage AC (V) EN 60903:	5,000V
Color:	RED

GLOVE FEATURES:

- Resistant to Acid & Low Temperatures. Certification: SATRA (UK).
- Made with special grade natural rubber compounds for assured electrical protection
- Each and every glove inspected/tested for electrical insulation
- Proof voltage tested on premium grade test machine, custom made in USA

PRODUCT TYPE: ELECTRICIAN - CLASS 0. LENGTH: 360MM

Model No:	GLV-RDSC-CL0
Sizes:	8, 9 & 10
Origin:	Sri Lanka, Manufactured & Certified to EN 60903:2003 Standard.
Product Type:	Electrician - CLASS 0 LENGTH: 360mm
Thickness* (mm):	EN 60903 - 1.60mm (Max)
Maximum Working Voltage AC (V):	1,000V
Proof Test Voltage AC (V):	5,000V
Withstand Test Voltage AC (V) EN 60903:	10,000V

PRODUCT TYPE: ELECTRICIAN - CLASS 1. LENGTH: 360MM

Model No:	GLV-RDSC-CL1
Sizes:	8, 9 & 10
Origin:	Sri Lanka, Manufactured & Certified to EN 60903:2003 Standard.
Product Type:	Electrician - CLASS 1 LENGTH: 360mm
Thickness* (mm):	EN 60903 - 2.10mm (Max)
Maximum Working Voltage AC (V):	7,500V
Proof Test Voltage AC (V):	10,000V
Withstand Test Voltage AC (V) EN 60903:	20,000V



Standard: Certified to EN 60903:2003

DPL LINEPRO INSULATED LINESMEN GLOVES

PRODUCT TYPE: ELECTRICIAN - CLASS 2. LENGTH: 360MM

Model No: GLV-RDSC-CL2

Sizes: 8, 9 & 10

Origin: Sri Lanka, Manufactured & Certified to EN 60903:2003 Standard

Product Type: **Electrician - CLASS 2** LENGTH: 360mm

Thickness* (mm): EN 60903 - 2.90mm (Max)

Maximum Working Voltage AC (V): 17,000V

Proof Test Voltage AC (V): 20,000V

Withstand Test Voltage AC (V) EN 60903: 30,000V



PRODUCT TYPE: ELECTRICIAN - CLASS 3. LENGTH: 360MM

Model No: GLV-RDSC-CL3

Size: 9

Origin: Sri Lanka, Manufactured & Certified to EN 60903:2003 Standard.

Product Type: **Electrician - CLASS 3** LENGTH: 360mm

Thickness* (mm): EN 60903 - 3.50mm (Max)

Maximum Working Voltage AC (V): 26,500V

Proof Test Voltage AC (V): 30,000V

Withstand Test Voltage AC (V) EN 60903: 40,000V

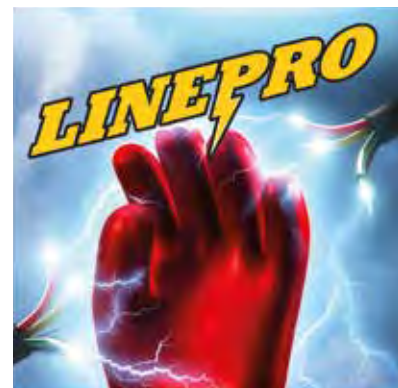

PRODUCT TYPE: ELECTRICIAN - CLASS 4. LENGTH: 410MM

Model No: GLV-RDSC-CL4

Sizes: 8, 9 & 10

Origin: Sri Lanka, Manufactured & Certified to EN 60903:2003 Standard

Product Type: **Electrician - CLASS 4** LENGTH: 410mm

Thickness* (mm): EN 60903 - 4.10mm (Max)

Maximum Working Voltage AC (V): 36,000V

Proof Test Voltage AC (V): 40,000V

Withstand Test Voltage AC (V) EN 60903: 50,000V



Standard: Certified to EN 388

LEATHER PROTECTOR GLOVES FOR LINEMEN'S INSULATED GLOVES

LEATHER PROTECTOR GLOVES FOR LINEMEN'S INSULATED GLOVES.

Model No: LPG-CL2-BLOKARC

Sizes: 9 & 10.

Brand: BLOKARCTM Standard: Certified to EN 388

Length: 10"

- Leather Protector Gloves are worn over Rubber Insulating Gloves to protect the gloves from any abrasions, cuts, tears and punctures that may occur when working
- Manufactured from Superior Goat Skin Leather with Cow Split Leather Cuff
- With a nylon strap and Black buckle that enables a secure and personal fit

Note: Leather Protector Gloves are not Insulated **OR** Arc Rated Gloves.

Primarily used for protecting Insulated Gloves.



NOTE: Insulated Gloves not included and quoted separately

LEATHER PROTECTOR GLOVES FOR LINEMEN'S INSULATED GLOVES.

Model No: LPG-CL4-BLOKARC

Sizes: 9 & 10

Brand: BLOKARCTM Standard: Certified to EN 388

Length: 13"

- Leather Protector Gloves are worn over Rubber Insulating Gloves to protect the gloves from any abrasions, cuts, tears and punctures that may occur when working
- Manufactured from Superior Goat Skin Leather with Cow Split Leather Cuff
- With a nylon strap and Black buckle that enables a secure and personal fit

Note: Leather Protector Gloves are not Insulated **OR** Arc Rated Gloves.

Primarily used for protecting Insulated Gloves.



NOTE: Insulated Gloves not included and quoted separately

GLOVE CARRY BAG, WHITE COLOR FOR INSULATED GLOVES**GLOVE CARRY BAG, WHITE COLOR FOR INSULATED GLOVES.****Model No:** GCB-CL2-BLOKARC**Sizes:** Length 400 mm x Width 220 mm**Brand:** BLOKARCTM

- Made from canvas.
- With Snap hook lets you hang this glove bag on your work belt

**GLOVE CARRY BAG, WHITE COLOR FOR INSULATED GLOVES.****Model No:** GCB-CL4-BLOKARC**Sizes:** Length 500 mm x Width 220 mm**Brand:** BLOKARCTM

- Made from canvas
- With Snap hook lets you hang this glove bag on your work belt

**WORK ITALIA (ITALY) INSULATED GLOVES PNEUMATIC TESTING KIT****Model :** VPG90**Brand:** WI. **Origin:** Italy

PNEUMATIC INFLATION TESTER. For detection of eventual perforations on dielectric gloves before the use of the individual protection device

COMPOSITION OF DEVICE:

- Made by thermoplastic material.
- Upper part tapered to allow easy insert and fixing of glove by the two elastic rings and provided with no return valve
- Lower side is composed by inflating body pump complete with compression spring and viton type o-ring for seal and sliding
- Suitable for periodic inspection test as specified by the European standard EN 60903 (International Standard IEC 903)



USA & EUROPEAN STANDARDS**HIGH VOLTAGE PROXIMITY NON-CONTACT DETECTOR****Model No:** HVP-275**Brand:** TECPEL, Made in Taiwan

- 8 voltage settings: 240Vac, 2kV, 6kV, 11kV, 22kV, 33kV, 132kV, and 275kV
- HVP-275 consists of an internal pickup sensor plate, a sensitivity selector, a visual and a sound annunciator
- High impact nylon casing

**HIGH VOLTAGE PROXIMITY NON-CONTACT DETECTOR****Model No:** HVP-277**Brand:** TECPEL, Made in Taiwan**Dimensions:** 318(L) x 75(W) x 71(D)mm

- 2 ranges for selection (2 function buttons) LOW : 50V-1.5kV
HIGH : 1.5kV-132kV
- **Power consumption:**
 - Off : Less than 5uA
 - Low voltage detection mode: Less than 40mA
 - High voltage detection mode: Less than 40mA
- **Circuit test function**
 - Press the Test button to make sure the whole circuit is working well before testing actual high voltage circuits

**ELECTRICAL SAFETY EQUIPMENT (LV, MV & HV)****VOLTAGE DETECTOR - CONTACT TYPE EUROPEAN TYPE****Model :** RMT 1030**Brand:** WI. **Origin:** Italy

Electronic Capacitive Detector of Voltage Presence / Absence on MV Lines and Installations by Visual and Acoustic Signalling
 Certified In Conformity with the International Standard CEI IEC 61243-1 Ed.2 2003-10

VOLTAGE RANGES:

- 3 - 9 KV
- 4 - 40 KV
- 40 - 70 KV

**Insulated Rod not included**

CONTACT VOLTAGE DETECTORS & INSULATED STICKS

HV VOLTAGE DETECTOR EUROPEAN TYPE

Model : RMT 3090

Brand: WI **Origin:** Italy

Electronic Capacitive Detector Of Voltage Presence / Absence
On HV Lines And Installations By Visual And Acoustic Signaling
Certified In Conformity with the International Standard
CEI IEC 61243-1 Ed.2 2003-10

VOLTAGE RANGES:

- 60 - 120 kV
- 110 - 380 kV
- 150 – 420 kV

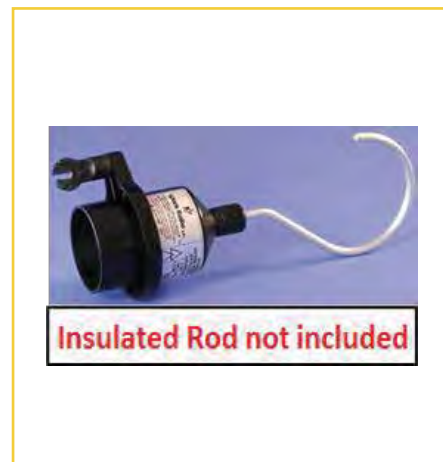

INSULATED STICK FOR VOLTAGE DETECTOR. UNIVERSAL SUNRISE FITTING

Model : P1-120U

Brand: WI **Origin:** Italy

Color: YELLOW

Length : 1.2 Mtrs

- High Insulating Rod made of Polyester resin reinforced by Fiberglass tube, external diameter 32mm
- Not Telescopic



INSULATED TELESCOPIC STICK WITH SUNRISE FITTING

Model : P2/200U-TEL

Brand: WI. **Origin:** Italy

Color: YELLOW

Length : 2.0 Mtrs

- High Insulating Telescopic Stick made of Polyester Resin reinforced by Fiberglass tubes
- Extended Length: 2.0 Mtrs
Folded Length nearly 1.1 Mtr



INSULATED STICKS FOR VOLTAGE DETECTORS

INSULATED TELESCOPIC STICK WITH SUNRISE FITTING

Model : P2/400U-TEL

Brand: WI **Origin:** Italy

Color: YELLOW

Length : 4.0 Mtrs

- High Insulating Telescopic Stick made of Polyester Resin reinforced by Fiberglass tubes
- Extended Length: 4.0 Mtrs



INSULATED STICK FOR VOLTAGE DETECTOR - UNIVERSAL SUNRISE FITTING

Model : P3/600U

Brand: WI. **Origin:** Italy

Color: YELLOW

- Total Length 6 Mtrs. in three elements, each 2.0 Mtrs. Length - connectable between them by fast joints
- lower rubber closing cap and hand guard on the base element
- universal splined attack type U on the head of the upper element for fixing of the voltage detector
- Not Telescopic



INSULATED STICK FOR EARTHING & GROUNDING EQUIPMENT

Model : P2/300DIN

Brand: WI **Origin:** Italy

Color: YELLOW

Length : 3.0 Mtrs **Diameter:** 40mm

- Total Length 3 M In Two Elements, Each 1,5 M. Length, Complete Of
- Quick Couplers To Connect The Two Elements
- Insulating Lower Closing Cap And Hand Guard Onto The Base Element
- Aluminium Bayonet Din Attack, Closing Cap And Hand Guard
- Not Telescopic



CEI IEC 61243-1 Ed.2 2003-10

INSULATED STICK FOR EARTHING & GROUNDING EQUIPMENT

Model : P2/400U

Brand: WI **Origin:** Italy

Color: YELLOW

Length : 4.0 Mtrs

Total Length 4 Mtrs In Two Elements, Each 2.0 Mtrs Length With:

Part No.P2/400u Tube Made By Polyester Resin Reinforced By Fibreglass,
4 Meters Length, In Two Elements With Universal Fitting For Mounting
Non Contact Voltage Detector

- Quick Couplers To Connect The Two Elements
- Insulating Lower Closing Cap And Hand Guard Onto The Base Element
- **Not Telescopic**



INSULATED SWITCH DISCONNECT STICK

Model : PE2-PV/245FA-GSN-TEL

Brand: WI **Origin:** Italy

Color: YELLOW

- Made by tubes made by synthetic resin reinforced by fiberglass certified in conformity with the International Standard CEI EN 61235 (IEC 61235)
- Maximum length 2.45 m
- Folded length about 0.90 m



INSULATED SWITCH DISCONNECT STICK

Model : PE2-PV/640FA-GSN-TEL

Brand: WI. **Origin:** Italy

Color: YELLOW

- Made by tubes made by synthetic resin reinforced by fiberglass certified in conformity with the International Standard CEI EN 61235 (IEC 61235)
- Maximum length 6.40 m
- Folded length about 2.20 m



DISCHARGE DEVICE FOR ELECTROSTATIC ENERGY

Model : WIP1/160FA-GSO-P2/2-MT33

Brand: WI **Origin:** Italy

COMPOSITION OF DEVICE:

- High insulating rod type P1/160FA made of polyester resin tube reinforced by fiberglass. **Length 1,6 m, Ø 32 mm**
- Extraflexible electrolytic copper cable covered by transparent plastic sheath section **25 mm², length 2m**
- Forged brass ground clamp type MT33 connected to one lug of the cable
Clamping capacity: round conductors and bars up to 33mm
- Metallic hook with threaded male M10 tang



TELESCOPIC HOOKED CLAMPSTICKS WITH SHOTGUN MOVEMENT

Model : PE-PVR/2010RC-TEL

Brand: WI **Origin:** Italy

Rated voltage Maximum: 150kV

For use and handling of tools and accessories fitted with a specific ring or gripper. Telescopic shotgun sticks can collapse for storage (2 M. Length) and extend to the length up to 2.5 M

COMPOSITION OF DEVICE:

- High Insulating tube PVR of vinylester resign reinforced by fiberglass filled by closed cells foam polyurethane certified in conformity with International Standard EN 60855 - IEC 60855, Ø 32 mm
- Press forged brass hook with foldaways movement
- Telescopic part made of high insulating tube type PE in epoxy resin reinforced by fiberglass, certified in conformity with International Standard EN 61235 - IEC 61235, Ø 40 mm



EARTHING & SHORT CIRCUITING KITS

Model : MT/BM-50

Brand: WI **Origin:** Italy

Short Circuiting and Grounding Equipment with Universal Contact Clamps for Electric Cabins and MV Installations with **cables section 50 mm² - Icc: 12.4 kA/1s**

- Ground electrolytic copper cable, **Length: 2m**
- Certified Type In Conformity With the International Standard EN 61230 (IEC 61230)



Model : MT/BM-50/5

Brand: WI **Origin:** Italy

Short Circuiting and Grounding Equipment with Universal Contact Clamps for MV Electric Cabins and Installations with **cables section 50 mm² - Icc: 13.77 kA/1s**

- 3 screw type universal contact clamps made of press forged brass
- 3 short circuit extraflexible electrolytic copper cables, covered by transparent plastic sheath, each length 0.75 m
- Central trifurcating connector
Ground cable, characteristics as above, **length 5m**
- Ground clamp made of press forged brass, clamping capacity up to 22 mm
- Insulating fiberglass rod type P2/135EF made of polyester resin reinforced by fiberglass tube
- Metallic case



Model : MT/BM-95

Brand: WI **Origin:** Italy

Short Circuiting And Grounding Equipment With Universal Contact Clamps For Electric Cabins And MV Installations. TYPE MT/BM-95 with **cable section 95 mm²**

Short circuit test: 20 kA / 1 s

- Ground electrolytic copper cable, **Length: 2m**
- Certified Types In Conformity With the International Standard CEI EN 61230 (IEC 1230)



Model : MT/BM-120

Brand: WI **Origin:** Italy

Short Circuiting And Grounding Equipment With Universal Contact Clamps For Electric Cabins And MV Installations. TYPE MT/BM-120 with **cable section 120 mm²**

Short circuit test: 32 kA / 1 s

- Ground electrolytic copper cable, **Length: 2m**
- Certified Types In Conformity With the International Standard CEI EN 61230 (IEC 61230)



EARTHING & SHORT CIRCUITING KITS

Model : MT/PF-50

Brand: WI **Origin:** Italy

Short Circuiting And Grounding Equipment With Universal Contact Clamps For Electric Cabins And MV Installations. TYPE MT/PF-95 with **cable section 50 mm²**. **Short circuit test: 12 kA / 1 s**. Certified Types In Conformity With the International Standard CEI EN 61230 (IEC 1230)

- 3 Screw type universal contact clamps type PF20-PF25 made by press forged brass with hexagonal tang for connection to the insulating rod (bayonet DIN tang on demand)
Clamping Capacity: ball earth fixed points 20 - 25 mm diameter (Please indicate the ball earth fixed points required in the event of an order)
- 3 Extra flexible electrolytic copper cables of short circuit, covered by transparent PVC sheath, for the connection between the three contact clamps and the central connector, **length 0.75 m**
- Central trifurcating connector
- Ground electrolytic copper cable, characteristics as above, **length 2 m**
- Ground clamp made by press forged brass, **clamping capacity up to 22 mm**
- Insulating fiberglass rod type PE2/135 EF made by epoxy resin reinforced by fiberglass, in two elements connected between them by quick coupler. **Length 1,35 m**
- Metallic carrying case

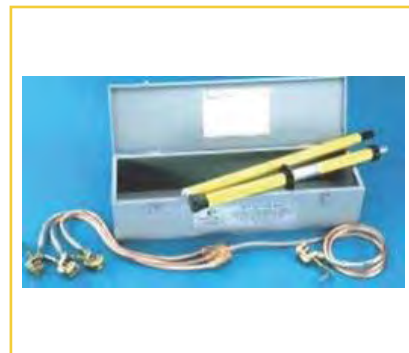

Model : MT/PF-95

Brand: WI **Origin:** Italy

Short Circuiting And Grounding Equipment With Universal Contact Clamps For Electric Cabins And MV Installations. TYPE MT/PF-95 with **cable section 95 mm²**. **Short circuit test: 20 kA / 1 s**. Certified Types In Conformity With the International Standard CEI EN 61230 (IEC 1230)

- 3 Screw type universal contact clamps type PF20-PF25 made by press forged brass with hexagonal tang for connection to the insulating rod
- 3 Extra flexible electrolytic copper cables of short circuit, covered by transparent PVC sheath, for the connection between the three contact clamps and the central connector, **length 0.75 m, complete**
- Central trifurcating connector
- Ground electrolytic copper cable, characteristics as above, **length 2 m**
- Ground clamp made by press forged brass, **clamping capacity up to 22 mm**
- Insulating fiberglass rod type PE2/135 EF made by epoxy resin reinforced by fiberglass, in two elements connected between them by quick coupler. **Length 1,35 m**
- Metallic carrying case

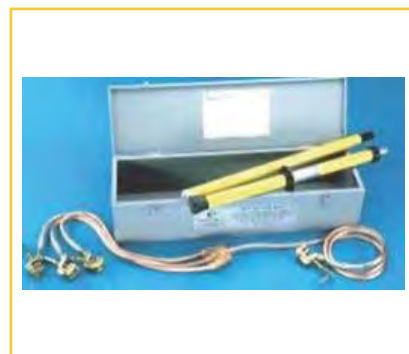

UNIPOLAR EARTHING DEVICE WITH INSULATING ROD

Model : WIBM-D-P7/6-MT25-UNI-P2/300DIN

Brand: WI Origin: Italy

IN CONFORMITY WITH INTERNATIONAL STANDARD IEC 61230

Icc of complete device **15,1 kA/1s**

- PC/BM-DIN Screw type universal contact clamp made by press forged brass tested for high intensity current
- Extra flexible electrolytic copper cable covered by transparent PVC sheath, **section 70mm², and length 6 m**
- Ground clamp for ball fixed point MT25
- High insulating rod made by polyester resin reinforced by fibreglass tube, external diameter 40mm, yellow colour. Total length 3 m in two elements, each 1.5 m. length

Note: The contact clamps of earthing device are installed on the phase by an insulating rod so, it is not an option. SPEC SHEET ATTACHED.



SHORT CIRCUITING AND GROUNDING EQUIPMENT FOR MV ELECTRIC CABINS/SUBSTATIONS

TYPE MT/535-S3/1,5-1/2,5-PE-PV/TEL-BPS

IN CONFORMITY WITH THE INTERNATIONAL STANDARD EN 61230 – IEC 61230. Icc: 9,6 kA/1 s

– n°3 Screw type universal contact clamps type **PC535** made of aluminum alloy tested for high intensity current

Hexagonal tang made of galvanized steel

- Clamping capacity:
- **round conductors 5-35 mm diameter;**
 - **flat conductors 16x40 mm;**
 - **bars on horizontal level 5x40 mm;**

- n°3 Extraflexible electrolytic copper cables of short circuit, covered by transparent silicone sheath, for the connection between the three contact clamps and the central connector. Section 35 mm², length 1,5 m, complete, at the extremities, of tinning copper lugs and reinforcements by transparent heat-shrink sheath
- Central trifurcating connector
- Ground electrolytic copper cable, characteristics as above, section 16mm², length 2,5 m
- Brass body-steel handle ground clamp made, clamping capacity up to 33 mm (round conductors and flat bars)
- Backpack for transport and storage
- CH18 metallic rod, 1m length
- Insulating rod **PE-PV/200EF-TEL**, extended length 2m
- Upper element made of vinylester resin reinforced by fibreglass tube, external diameter 32 mm, orange colour, certified in conformity with the International Standard **IEC 61235**. Complete of hexagonal CH12-thread M10 fitting type EF on the top
- base element made of epoxy resin reinforced by fibreglass, external diameter 40 mm, yellow colour, certified in conformity with the International Standard **IEC 61235**
- Complete of lower rubber cap and hand guard
- Special double locking system to work at every extension of the stick from about 1,1m up to 2m
- Bag for transport and storage of the rods



ELECTRICAL SAFETY KIT (PANOPLY KIT)

Model : SZ-51S

Brand: SOFAMEL **Origin:** SPAIN

In the event of an electrical accident, fast intervention is essential. The panel contains all the rescue tools in a single place making it accessible to all users when an intervention is necessary

COMPOSED OF A 1 X 1.6 M BOARD CONTAINING THE FOLLOWING ELEMENTS:

- 1 BS-45 rescue pole
- 1 plastic case for gloves
- 1 pair of dielectric gloves (class 3)
- 1 SZ-57/25 insulated wire cutter
- 1 pipette
- 1 45 kV insulating stool
- 1 first aid plate
- 1 instruction plate



ELECTRICAL SAFETY KIT (PANOPLY KIT)

Model : SZ-51M

Brand: SOFAMEL **Origin:** SPAIN

In the event of an electrical accident, fast intervention is essential. The panel contains all the rescue tools in a single place making it accessible to all users when an intervention is necessary

COMPOSED OF A 1 X 1.6 M BOARD CONTAINING THE FOLLOWING ELEMENTS:

- 1 No. BS-45 rescue pole
- 1 No. 5-36 kV voltage detector with pole
- 1 No. plastic case for glove
- 1 Pair of dielectric gloves (class 3)
- 1 No. SZ-57/25 insulated wire cutter
- 1 No. pipette.
- 1 No. 45 kV insulating stool
- 1 Pair of insulating shoes
- 1 No. first aid plate
- 1 No. instruction plate



PORTABLE ELECTRIC SHOCK RESCUE KIT

Model : KRM-4001

Brand: SOFAMEL **Origin:** SPAIN

ELEMENTS OF THE KIT:

- 1 No. 1.5 m telescopic pole of three sections.
- 1 No. optical and acoustical detector from 5 to 36 kV with bag.
- 1 No. rescue hook with universal head.
- 1 Pair of dielectric gloves SG-40 T10 stored in a nylon bag.
- 1 No. insulating mat AD4-0610/40C of 60 cm x 1 m, working voltage 36 kV.
- 1 No. respiration pipette.
- 1 No. neck immobilizer.
- 1 No. fire resistant blanket SZ-180 of 1.2 x 1.8 m.
- 1 No. stretcher.



FIBREGLASS ELECTRIC SHOCK RESCUE STICKS

Model : BS-45

Brand: SOFAMEL **Origin:** SPAIN

Length: 1.79 Mtrs **Working Voltage:** 45 kV

Rescue pole with only one section made of polyester and fibreglass tube Ø 32 mm with humidity-proof seals on each end, hand protector, grip, tip, M-10 metric head and rescue hook

- Used To Remove The Casualty From The Danger Area In Rescue Operations



FIBREGLASS ELECTRIC SHOCK RESCUE STICKS

Model : BS-66

Brand: SOFAMEL **Origin:** SPAIN

Length: 2.29 Mtrs **Working Voltage:** 66 kV

Rescue pole with only one section made of polyester and fibreglass tube Ø 32 mm with humidity-proof seals on each end, hand protector, grip, tip, M-10 metric head and rescue hook.

- Used To Remove The Casualty From The Danger Area In Rescue Operations



ROBUST PLASTIC WALL SUPPORT FOR POLES

Model : 615206

Brand: SOFAMEL **Origin:** SPAIN

Product supplied with screws and nail plugs

Price includes for both pole holder (1 Pc.) and bottom support bracket (1 Pc.)

NOTE: Rescue Sticks are not included



INSULATED PLATFORM / STOOL FOR INDOOR USE. WORKING VOLTAGE: 45 KV

Model : ST-45

Brand: SOFAMEL **Origin:** SPAIN

Platform Size: 525 mm x 525 mm. **Working Voltage:** 45 KV

Surface Size: 575 mm x 575 mm.

Height: 305 mm. CLASS 5. Code: 580110

PRODUCT DETAILS:

- Made of High Impact Copolymer Polypropylene
- The platform surface is rough and non-slip. Rubber tips are placed under the legs to give it greater adherence to the floor and protection from wear
- According to UNE 204001 standard



INSULATED PLATFORM / STOOL FOR INDOOR USE. WORKING VOLTAGE: 66 KV

Model : ST-66

Brand: SOFAMEL **Origin:** SPAIN

Platform Size: 525 mm x 525 mm **Working Voltage:** 66 KV

Surface Size: 575 mm x 575 mm

Height: 305 mm. CLASS 6. Code: 580115

PRODUCT DETAILS:

- Made of High Impact Copolymer Polypropylene
- The platform surface is rough and non-slip. Rubber tips are placed under the legs to give it greater adherence to the floor and protection from wear
- According to UNE 204001 standard



PORTABLE ELECTRIC SHOCK RESCUE KIT - 25kV

Model : VES25

Brand: SIBILLE SAFE

Origin: FRANCE

SPECIFICATIONS:

- Insulating stool: 25 000V
- Insulating gloves: GLB3-36-10 (class 3)
- Insulating boots TB19: protection against step voltage (voltage gradient in the ground)
- Insulating stick PPOLVES, equipped with a hook CSVES: telescopic stick with pentagonal shape for a perfect grip
- Voltage detector TDPESEC: detects all voltages of 127 VAC and above (does not detect DC voltages)
- Cable cutter CCIVES: Insulated 36 000V cable cutter
- Talc shaker TS10T: for easier donning of gloves
- Fabric case for gloves TS10: Mechanical and UV protection
- Adhesive marker tape S174JN: for marking off an area, preventing a disconnect switch from being reset, etc
- Instruction for use VESNOT: in diagram form for quick reading and guidance



PORTABLE ELECTRIC SHOCK RESCUE KIT - 36kV

Model : VES36

Brand: SIBILLE SAFE

Origin: FRANCE

SPECIFICATIONS:

- Insulating stool: 36 000V
- Insulating gloves: GLB4-41-10 (class 4)
- Insulating boots TB19: protection against step voltage (voltage gradient in the ground)
- Insulating stick PPOLVES, equipped with a hook CSVES: telescopic stick with pentagonal shape for a perfect grip
- Voltage detector TDPESEC: detects all voltages of 127 VAC and above (does not detect DC voltages)
- Cable cutter CCIVES: Insulated 36 000V cable cutter
- Talc shaker TS10T: for easier donning of gloves
- Fabric case for gloves TS10: Mechanical and UV protection
- Adhesive marker tape S174JN: for marking off an area, preventing a disconnect switch from being reset, etc
- Instruction for use VESNOT: in diagram form for quick reading and guidance



PORTABLE ELECTRIC SHOCK RESCUE KIT - 25kV

Model : CZ-53

Brand: CATU **Origin:** FRANCE

Operating Voltage: 25 kV AC

KIT COMPONENTS

- 01 No. Insulating Stool
- 01 No. Yellow Telescopic Stick
- 01 No. Hook fitted with a voltage detector
- 01 No. Cable cutter
- 01 Pair of Insulating Gloves
- 01 No. Protection case for the gloves
- 01 Pair of Insulating Boots
- 01 No. Talcum Bottle
- 01 No. Adhesive Tape
- 01 No. Poster " First Aid for Electric Shock Victims"
- Visual instruction for use



WALL MOUNTED ELECTRIC SHOCK RESCUE KIT

Model : CZ-54

Brand: CATU **Origin:** FRANCE

WALL MOUNTED BOARD WITH A CLEAR DOOR AND STRAPS TO FIX THE BELOW COMPONENTS

- This kit is especially designed for rescue interventions with electrical risk
- 01 No. insulating platform 24 kV (phase/ground) CT-7-25/1
- 01 Pair insulating gloves 26,5 kV, CG-30-C, class 3 size C (10) of IEC standard
- 01 No. telescopic stick 45 kV with rescue hook
- 01 No. voltage detector (3 to 40kV) with flexible contact antenna fixed on the hook ref. M952170
- 01 Pair insulating boots to protect against the electrical risks of voltage when stepping on the ground MV-137/45 (size 45)
- 01 No. cable cutter with insulated handles 25 kV
- 01 No. talcum powder can
- 01 No. Safety instructions on the plastic board
- 01 No. instruction manual
- 01 Fixing Kit



WALL MOUNTED ELECTRIC SHOCK RESCUE KIT

Model : CZ-55

Brand: CATU

Origin: FRANCE

WALL MOUNTED BOARD WITH A CLEAR DOOR AND STRAPS TO FIX THE BELOW COMPONENTS

- This kit is especially designed for rescue interventions with electrical risk
- 01 No. Insulating Platform 40 kV (phase/ground).CT-7-40/1
- 01 Pair of Insulating Gloves 36 kV, class 4 of IEC standard. CG-40-C
- 01 No. Telescopic Stick 45 kV with Rescue Hook CS-45
- 01 No. Voltage Detector CL-4-03 (3 to 40kv) with flexible contact antenna fixed on the hook.
- 01 Pair of Insulating Boot to protect against the electrical risks of voltage when stepping on the ground. MV-137/45 (size 45)
- 01 No. Cable Cutter with insulated handles. CZ-60
- 01 No. Talcum Powder can.M952120
- Safety Instructions on the plastic board
- 01 No. Instruction Manual
- 01 Set Fixing kit



LOTO-LOK® ELECTRIC SHOCK POSTERS

Brand: LOTO-LOK®

Origin: INDIA

Dimensions: L 750 mm x W 500 mm



Model No: EL - 01
" ELECTRIC SHOCK " POSTER



Model No: EL - 02
" SAFETY TIPS, ELECTRICAL SAFETY " POSTER



Model No: EL - 04
" ELECTRIC SHOCK RESCUE " POSTER

LOTO-MAT ELECTRICAL INSULATION MATTING

ELECTRICAL INSULATION MATTING - CLASS 0

Model : IRM-CL0-1

Brand: LOTO-MAT Origin: SLOVAKIA (EU)

Color: ORANGE, Anti-Skid Ribbed Switchboard Matting

Size: Width 1.0 Mtr. x Length 1.0 Mtr Thickness: 1.0 mm

Working Voltage : 1000 V

Test Voltage : 2500 V

European Standard IEC 61111:2009

Packaging: 1.0 Mtr. Length per piece



LOTO-MAT ELECTRICAL INSULATION MATTING

ELECTRICAL INSULATION MATTING ANTI-SKID RIBBED SWITCHBOARD MATTING

CLASS 0

Model : IRM-CL0

Brand: LOTO-MAT Origin: SLOVAKIA (EU)

Color: GREY

Size: Width 1.2 Mtr x Length 10.0 Mtr

Thickness: 3.0 mm

Working Voltage : 1000 V

Test Voltage : 2500 V

European Standard IEC 61111:2009



CLASS 2

Model : IRM-CL2

Brand: LOTO-MAT Origin: SLOVAKIA (EU)

Color: GREY

Size: Width 1.2 Mtr. x Length 10.0 Mtrs.

Thickness: 3.0 mm

Working Voltage : 17000 V

Test Voltage : 20000 V

European Standard IEC 61111:2009



CLASS 4

Model : IRM-CL4

Brand: LOTO-MAT Origin: SLOVAKIA (EU)

Color: GREY

Size: Width 1.2 Mtr. x Length 10.0 Mtrs

Thickness: 4.5 mm

Working Voltage : 36000 V

Test Voltage : 40000 V

European Standard IEC 61111:2009

Packaging: 10.0 Mtrs. Length per Roll



HUBIX (POLAND) RUBBER INSULATING BLANKET**Model :** H031 - 10**Brand:** HUBIX **Origin:** Made in POLAND**Size:** 1000 x 800mm - Plain Blanket**Weight:** 1250 g/m²

- Made of synthetic rubber. Equipment is controlled and tested in accordance with EN 61112:2009 Thickness: 1,3mm ±0,2mm Weight:~1250g/m² Tensile strength: 12MPa
- Live working up to 1000V a.c. and 1500V d.c. It is used to insulation work areas on overhead lines and connectig boxes

**HUBIX (POLAND) INSULATING CLAMP****Model :** H034-M**Brand:** HUBIX **Origin:** Made in POLAND

- Insulation tool. Made of red polyamide reinforced with fiberglass, injection technology. it has a metal spring that rnsures the pressure of both arm. Execution and testing of the product in accordance with EN 60900:2012
- The Clip is designed for work under voltage up to 1000V AC or 1500V DC It is used for fixing insulating covers in swithching devices and cable lines up to 1kV. The wide spacing of the jaws allows attaching covers to elements up to 50mm

**HUBIX (POLAND) INSULATING STICK HANDLE WIRE CUTTER****Model :** A222.1001**Brand:** HUBIX **Origin:** Made in POLAND**SPECIFICATIONS:**

- Insulating Working Voltage: 36kV AC
- Max Diameter Wires: 25mm
- Length: 820mm
- Weight: 2.2 Kgs
- Steel Jaw blades attached to handles made of fiber glass Pipes saturated with epoxy resin with a diameter of 32mm, filled with polyurethane foam
The handles of the tool are equipped with grip limiters, preventing the hand from slipping towards the blades. The ends of the handle, both from the side of the blades and the handle, are secured with pads made of soft PVC



OBERON (USA) ARC™ SERIES 15 KA ARC FLASH SUPPRESSION BLANKETS

Model : ARCBKT-15KA-S (Small Size) / ARCBKT-15KA-L (Large Size)

Brand: OBERON **Origin:** Made in USA

Size: Small blanket is 4' x 5' / Large blanket is 5' x 8'

Color: KHAKI

- Meets and exceeds ASTM F2676 blanket standard and is rated for a maximum arc current of 15 kA (BTP 181)
- Designed to divert energy away from the worker while performing underground or confined space tasks
- **Each 4' x 5' blanket comes with 10 kevlar® rope straps** 48" in length to safely secure the blanket for use
- **Each 5' x 8' blanket comes with 14 kevlar® rope straps** 48" in length to safely secure the blanket for use

Note: Arc Flash blankets do not provide insulation from shock



OBERON (USA) ARC™ SERIES 25 KA ARC FLASH SUPPRESSION BLANKETS

Model : ARCBKT-25KA-S (Small Size) / ARCBKT-25KA-L (Large Size)

Brand: OBERON **Origin:** Made in USA

Size: Small blanket is 4' x 5' / Large blanket is 5' x 8'

Color: KHAKI

- Meets and exceeds ASTM F2676 blanket standard and is rated for a maximum arc current of 25 kA (BTP 272)
- Designed to divert energy away from the worker while performing underground or confined space tasks
- **Each 4' x 5' blanket comes with 10 kevlar® rope straps** 48" in length to safely secure the blanket for use
- **Each 5' x 8' blanket comes with 14 kevlar® rope straps** 48" in length to safely secure the blanket for use

Note: Arc Flash blankets do not provide insulation from shock



NON-CONTACT VOLTAGE DETECTOR PEN

Model : PM8908C

Brand: PEAK METER

Origin: CHINA

Features: PM8908C is smart and compact pen type meter with mini size for easy carrying. It is designed according to EN61010-1-2-030, EN61010-2-033, CAT III1000V Concerning Safety -Requirements

PRODUCT DESCRIPTION:

- Range of Voltage sensitivity is from 12V to 1000V AC.
- Rotatable Battery Cover, Replacing The Battery Easier
- Distinguish The Zero Line And Fire Line Automatically
- Sound And Led Alarm, The Instrument Uses The Alarm Sound Of Different Frequency And Led Lamp Of Different Color To Indicate Low.moderate Or High Sensitivity
- Professional Ac Voltage Detector With Ncv Detection
- Sound And Light Instructions
- Auto Power Off
- High Quality And Easy-to-use
- Mini And Compact Pen, Easy To Carry

SPECIFICATION:

- AC voltage detection range: About12~~1000V/48~~1000V.
- Frequency: 50-60Hz
- Alarm Mode: Sound and light
- Flash Light: White
- NCV Sensitivity: Automatic selection of 3 kinds of sensitivity (low, medium, high).
- Operating Temperature: 32 to 122F (0 to 50 degree)
- Battery: 2 * 1.5V AAA Batteries
(batteries are not included).
- Item dimensions: 16 * 2 * 2 cm
- Item weight: About 45g.



SOCKET TESTER

Model : PM6860ER

Brand: PEAK METER **Origin:** CHINA

PRODUCT DESCRIPTION:

- The professional Socket Tester
- The easy way to find out if your sockets are safe!
- Reliable and easy to use Modern, ergonomic design with unique soft finger grip
- Compact, durable-designed to Safety Standard
- EN61010 Clear LEDs indicate a range of wiring condition

SPECIFICATION:

- Voltage Ranger: 230V
- GFCI / RCD Test: ✓
- Tripping: > 30mA
- Flash Light: White
- Auto Power Off: Yes
- LED Indicate Condition of the Socket's wiring:
- Correct connection
- Missing Earth
- Live-Earth Reverse
- Live-Neutral Reverse
- Missing Neutral
- Product Size: 65mm x 61mm x 61mm
- Weight: 60g
- Safety Rating: CE CAT.II 600V RoHS



INFRARED THERMOMETER

Model : PM6530B

Brand: Peak Meter

Origin: CHINA

This product is a professional, hand-held meter for non-contact Infrared and K-type thermocouple temperature measurement that is simple to use, highly accurate, and with a wide temperature range.

SPECIFICATION:

- **IR Temperature Range:**
 -30°C~500°C
 -22°F~932°F
- **Ambient Temperature:**
 -20~60°C(±0.5°C/1.0°F)
 -4~140°F(±0.5°C/1.0°F)
- **Safety Rating:** EN61326, EN 60825
- **Size:** 136 × 97 × 33mm
- **Approx.**130g



INFRARED THERMOMETER WITH HUMIDITY & DEW

Model : PM6530B

Brand: Peak Meter

Origin: CHINA

MEASUREMENT RANGE:

- **IRT Temp:** -50~800°C (-122~1472°F)
- **K-type Temp:** -40~500°C(-40~932°F)
- **Ambient Temp:** -20~60°C (-4~140°F)
- **RMP:** 50~99999RPM +/-2RPM

ACCURACY:

- **IRT Temp:** +/-1.5%rdg
- **Ambient Temp:** +/-1.5%rdg
- **K-type Temp:** +/-1.5%rdg
- **Operating Temp:** -10~40°C
- **Storage Temp:** -20~60°C



THREE PHASE ROTATION INDICATOR (MOTOR PHASE ROTATION INDICATOR)

Model : MS5900

Brand: Peak Meter **Origin:** CHINA

SPECIFICATION:

- PEAKMETER MS5900 Motor and Phase Rotation Indicator is used to test magnetic field direction of three-phase system, phase rotation, motor rotation direction
- Operating Voltage: 120V~400V AC
- Current Consumption: ≤ 20mA
- Frequency Range: 2Hz ~ 400Hz
- Power Supply 3x1.5AA Battery (Not Included)
- Category CE CAT.III 600V RoHS
- Product Size: 128mm x70mm x30mm
- Approx. 168g



SAFETY RUBBER MAGNETIC SIGNS

Brand: LOTO-LOK®

Origin: CHINA

Size: 200mm x 100mm.



Model No: LSP-MCS-01

" CAUTION, Equipment Locked Out, Do Not Operate " MAGNETIC SIGN.



Model No: SIGN-MCS-03

" DANGER, ENTRY OF UNAUTHORISED PERSONS PROHIBITED " MAGNETIC SIGN.



Model No: LSP-MCS-02

" DANGER, ENTRY OF UNAUTHORISED PERSONS PROHIBITED " MAGNETIC SIGN.

ACCESSORIES

SAFETY SPECTACLES

Model : SAMARAY-20060 / 61

Brand: CANASAFE **Origin:** CANADA

Black/Yellow Frame, Clear A/F Lens (20060)

SamaRay, Black/Yellow Frame, Gray A/F Lens (20061)

FEATURES:

- Adjustable length
- Eyeglass cord included
- Angle adjustment
- High impact polycarbonate with i-Cote™ anti-fog/anti-scratch 99.9% UV protection lenses
- Molded-in universal nose-bridge
- Integral side shield
- Meets ANSI Z87.1-2010 Standard



BRIGHT STAR 2 CELL FLASH LIGHT

Model : BS-2618

Brand: Brightstar **Origin:** USA



DUFFLE TOTE ELECTRICAL GEAR BAG

Model : BG-RD62EG

Brand: LOK-FORCE™ **Origin:** CHINA

Color: Red

FEATURES:

- With Silk Screen printed "ELECTRICAL GEAR" on front side of bag
- With 2 carry handles
- For storing and transporting Electrical PPE equipment



FLASHING LIGHT

Model : LSP-FLSH-LITE

Origin: CHINA

- Yellow color with Magnetic Base
- AA Battery operated.



ACCESSORIES

ELECTRIC SHOCK BURNS FIRST AID KIT

Model : RELIANCE-FAK

Brand: Reliance Medical

Dimensions: 22.5 x 22 x 9 cms

FEATURES:

- Specifically stocked for treating burns
- Provides fast and effective treatment
- Meets current HSE guidelines
- Includes integral bracket



FULL BODY SAFETY HARNESSSES

Model : LX550 + LX121

Brand: LIFTEK

Origin: UK

INCLUDES THE FOLLOWING:

- With work positioning Belt
- Double webbing lanyard with shock absorber (LX121)
- 1 carabineer (LX03)
- 2 rebar hook (LX02)



PLASTIC FLEXIBLE BARRIER

Model : LSP-FLEX-BAR

Origin: CHINA

Height: 90 cms

Open Length: 200 cms

Closed Length: 24 cms



SAFETY REFLECTOR VEST

Model : LSP-RV

Origin: CHINA

Color: Yellow with silver reflector strips

Sizes : L, XL, 2XL

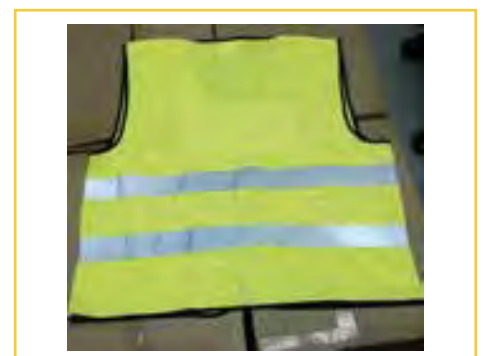



LOTO Safety Products DMCC, its owners and employees disclaims liability for any injury to persons or to property, or other damages of any nature whatsoever, whether special, indirect, consequential or compensatory, directly or indirectly resulting from the use of **OR** reliance on information in Pages 1 – 5 (Arc Flash Basics) of this catalog.

The information provided on Pages 1 – 5 is designed for educational use only and is not a substitute for any specific training or experience.

LOTO Safety Products DMCC, its owners and employees also makes no guaranty or warranty as to the accuracy or completeness of any information published herein and assumes no liability for any individual's use of or reliance on Arc Flash Basics Pages 1 - 5 of this Catalog.

The contents stated in Arc Flash Basics Pages 1 - 5 contained in this catalog may not be the most current.

ARC FLASH PROTECTION PPE



SAVES LIVES

LOCKOUT / TAGOUT

is your facility compliant to OSHA 29 CFR 1910.147 standard?

LOCKOUT / TAGOUT

 Electrical Lockouts

 Identification

 Mechanical Lockouts

 Assessment

 Safety Padlocks

 Demonstration

 Danger Tags

 Supply

 Group Lockout

 Installation Support

voltage detectors

12 cal PPE

electrical safety shoes

insulated platforms insulated gloves

72 cal PPE

JACKETS TROUSERS SHIRTS COVERALLS

earthing kits 10 cal PPE

45 CAL PPE 26 cal PPE

ARC FLASH PPE KITS

shock rescue equipment

INSULATED MATTING

100 cal PPE



LOTO SAFETY REQUISITES TRADING L.L.C.

Belresheed Warehouse No.7, Next To Jacky's Electronics, Nad Al Hamar, P.O Box 114738, Dubai - UAE

Tel: +971-4-4539779 E-mail: info@lotosafetyproducts.com www.lotosafetyproducts.com

50 KEY CABINET - FEATURES

— Model No: KC-LFLD-50 —

Manufactured from SPCC cold rolled steel



 Heavy gauge steel construction cabinet

- Scratch-resistant finish.
- Full piano length hinge.
- Fixed hooks.
- 2 keys with each lock.

CABINET DIMENSIONS: 240 x 300 x 75mm	CARTON DIMENSIONS: 310 x 245 x 85mm
GROSS WT: 2.0 kgs.	NET WT: 1.90 kgs.

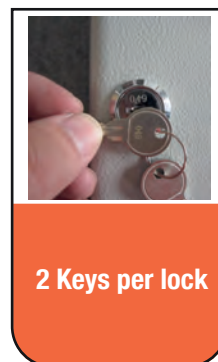

50 KEY CABINET - FEATURES

— Model No: KC-LFHD-50 —

Manufactured from SPCC cold rolled steel



Heavy gauge steel construction cabinet

- Scratch-resistant finish.
- Full piano length hinge.
- Adjustable color coded hooks with numbers.
- 2 keys with each lock.

CABINET DIMENSIONS: 550 x 380 x 80mm	CARTON DIMENSIONS: 610 x 440 x 140mm
GROSS WT: 5.80 kgs.	NET WT: 5.60 kgs.

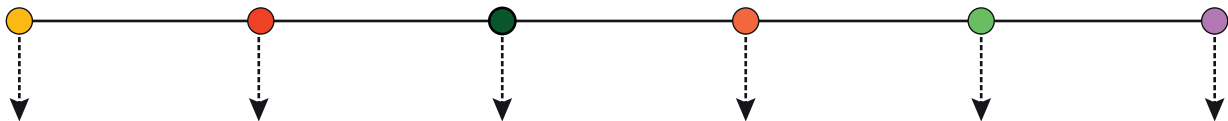

Assorted colored key tags with each cabinet

Adjustable hooks with numbers

Wall fixing accessories with each cabinet

2 Keys per lock

Heavy duty construction

Boxed Packing

LOK-FORCE™

100 KEY CABINET - FEATURES

— Model No: KC-LFHD-100 —

Manufactured from SPCC cold rolled steel



 Heavy gauge steel construction cabinet

- Scratch-resistant finish.
- Full piano length hinge.
- Adjustable color coded hooks with numbers.
- 2 keys with each lock.

CABINET DIMENSIONS: 550 x 380 x 80mm	CARTON DIMENSIONS: 610 x 440 x 140mm
GROSS WT: 6.50 kgs.	NET WT: 6.20 kgs.

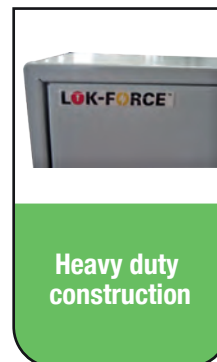
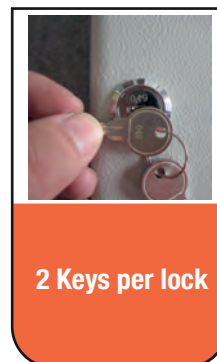
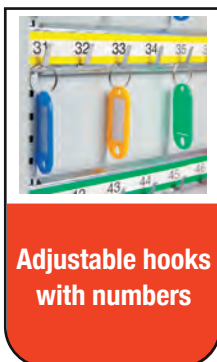
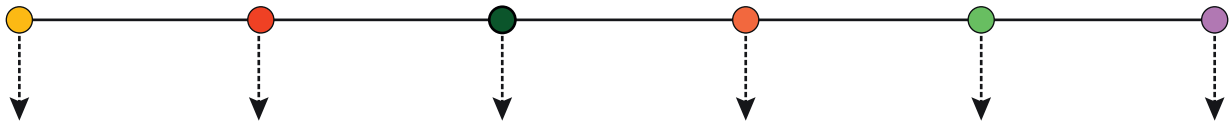

LOTO SAFETY REQUISITES TRADING L.L.C.

Belresheed Warehouse No.7, Next To Jacky's Electronics, Nad Al Hamar, P.O Box 114738, Dubai - UAE

Tel: +971-4-4539779 E-mail: info@lotosafetyproducts.com www.lotosafetyproducts.com

LOK-FORCE™

150 KEY CABINET - FEATURES

— Model No: KC-LFHD-150 —

Manufactured from SPCC cold rolled steel



 Heavy gauge steel construction cabinet

- Scratch-resistant finish.
- Full piano length hinge.
- Adjustable color coded hooks with numbers.
- 2 keys with each lock.

CABINET DIMENSIONS: 380 x 550 x 140mm	CARTON DIMENSIONS: 440 x 610 x 200mm
GROSS WT: 8.10 kgs.	NET WT: 7.80 kgs.

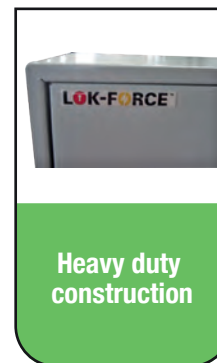
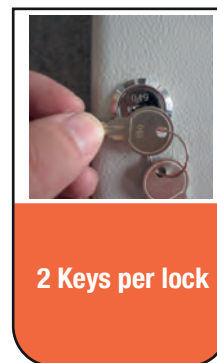
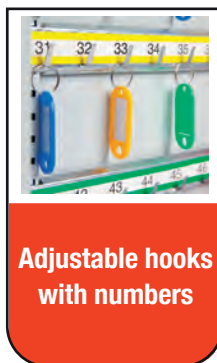

LOTO SAFETY REQUISITES TRADING L.L.C.

Belresheed Warehouse No.7, Next To Jacky's Electronics, Nad Al Hamar, P.O Box 114738, Dubai - UAE

Tel: +971-4-4539779 E-mail: info@lotosafetyproducts.com www.lotosafetyproducts.com

LOK-FORCE™

200 KEY CABINET - FEATURES

— Model No: KC-LFHD-200 —

Manufactured from SPCC cold rolled steel



 Heavy gauge steel construction cabinet

- Scratch-resistant finish.
- Full piano length hinge.
- Adjustable color coded hooks with numbers.
- 2 keys with each lock.

CABINET DIMENSIONS: 380 x 550 x 140mm	CARTON DIMENSIONS: 440 x 610 x 200mm
GROSS WT: 9.6 kgs.	NET WT: 9.3 kgs.

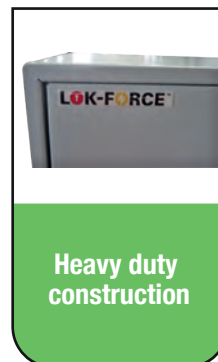
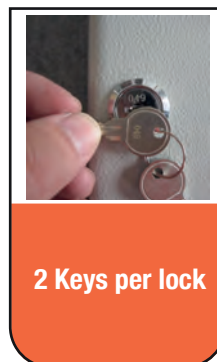
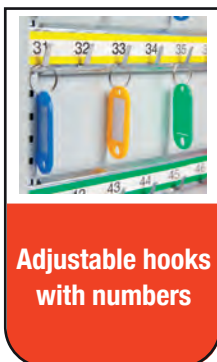
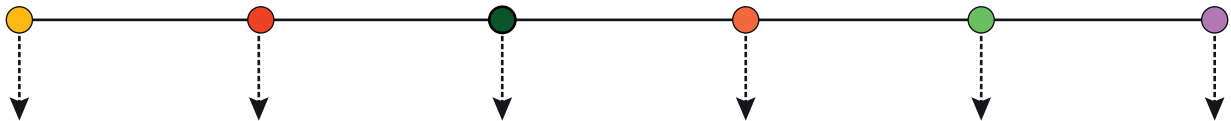

LOTO SAFETY REQUISITES TRADING L.L.C.

Belresheed Warehouse No.7, Next To Jacky's Electronics, Nad Al Hamar, P.O Box 114738, Dubai - UAE

Tel: +971-4-4539779 E-mail: info@lotosafetyproducts.com www.lotosafetyproducts.com

LOK-FORCE™

300 KEY CABINET - FEATURES

— Model No: KC-LFHD-300 —

Manufactured from SPCC cold rolled steel



 Heavy gauge steel construction cabinet

- Scratch-resistant finish.
- Full piano length hinge.
- Adjustable color coded hooks with numbers.
- 2 keys with each lock.

CABINET DIMENSIONS: 550 x 380 x 205mm	CARTON DIMENSIONS: 620 x 430 x 280mm
GROSS WT: 20.6 kgs.	NET WT: 20.1 kgs.

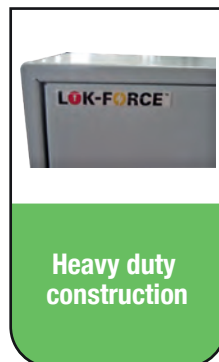
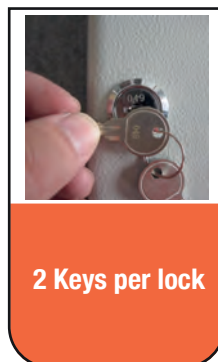
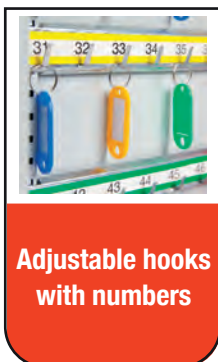
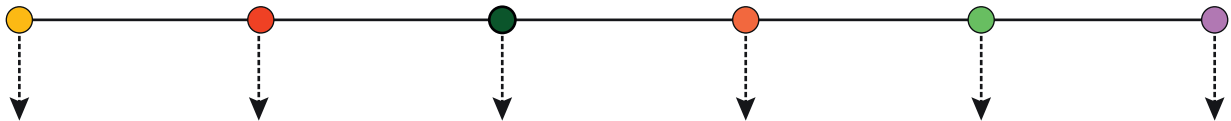

LOTO SAFETY REQUISITES TRADING L.L.C.

Belresheed Warehouse No.7, Next To Jacky's Electronics, Nad Al Hamar, P.O Box 114738, Dubai - UAE

Tel: +971-4-4539779 E-mail: info@lotosafetyproducts.com www.lotosafetyproducts.com

LOK-FORCE™

400 KEY CABINET - FEATURES

— Model No: KC-LFHD-400 —

Manufactured from SPCC cold rolled steel

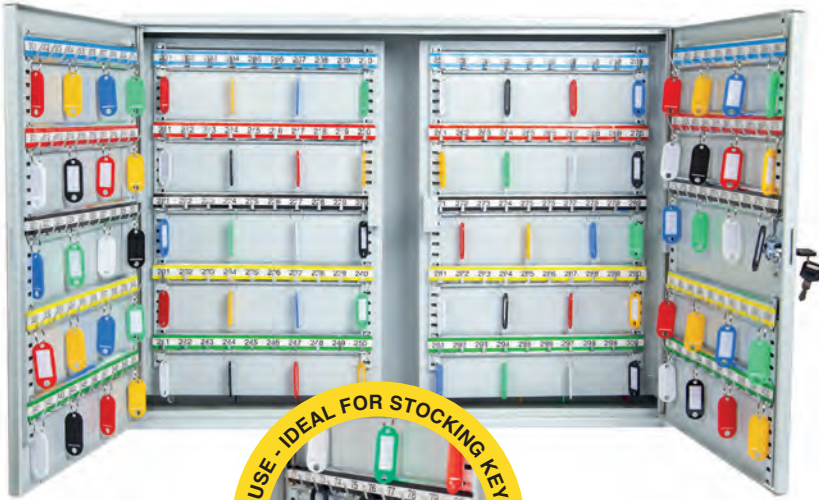

DUAL USE - IDEAL FOR STOCKING KEYS & PADLOCKS

 Heavy gauge steel construction cabinet

- Scratch-resistant finish.
- Full piano length hinge.
- Adjustable color coded hooks with numbers.
- 2 keys with each lock.

CABINET DIMENSIONS: 730 x 550 x 140mm	CARTON DIMENSIONS: 790 x 610 x 200mm
GROSS WT: 22.3 kgs.	NET WT: 21.8 kgs.

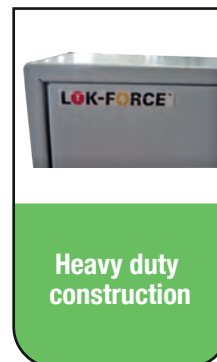
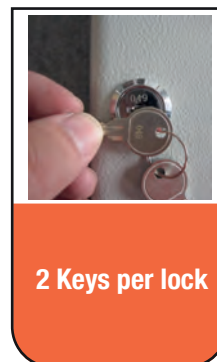
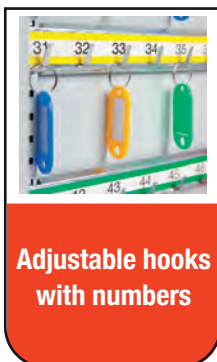
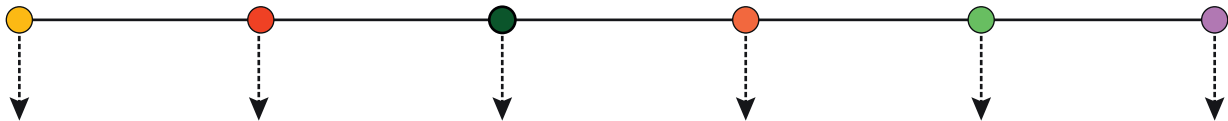

LOTO SAFETY REQUISITES TRADING L.L.C.

Belresheed Warehouse No.7, Next To Jacky's Electronics, Nad Al Hamar, P.O Box 114738, Dubai - UAE

Tel: +971-4-4539779 E-mail: info@lotosafetyproducts.com www.lotosafetyproducts.com

LOK-FORCE™

600 KEY CABINET - FEATURES

— Model No: KC-LFHD-600 —

Manufactured from SPCC cold rolled steel



Heavy gauge steel construction cabinet

- Scratch-resistant finish.
- Full piano length hinge.
- Adjustable color coded hooks with numbers.
- 2 keys with each lock.

CABINET DIMENSIONS: 730 x 550 x 205mm	CARTON DIMENSIONS: 790 x 610 x 265mm
GROSS WT: 30.7 kgs.	NET WT: 30.2 kgs.

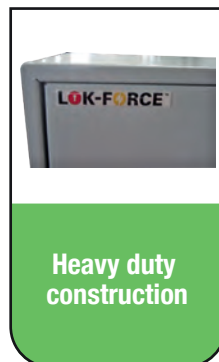
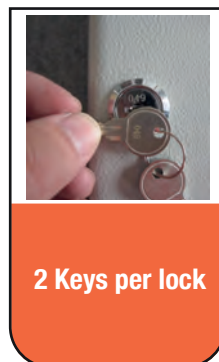
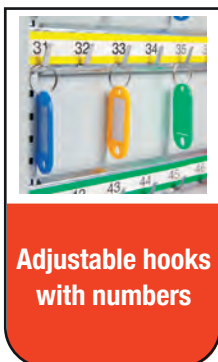
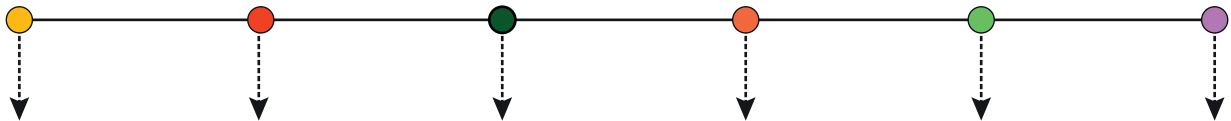

LOTO SAFETY REQUISITES TRADING L.L.C.

Belresheed Warehouse No.7, Next To Jacky's Electronics, Nad Al Hamar, P.O Box 114738, Dubai - UAE

Tel: +971-4-4539779 E-mail: info@lotosafetyproducts.com www.lotosafetyproducts.com

LOK-FORCE™

1170 KEY CABINET - FEATURES

— Model No: KC-LFHD-1170 —

Manufactured from SPCC cold rolled steel

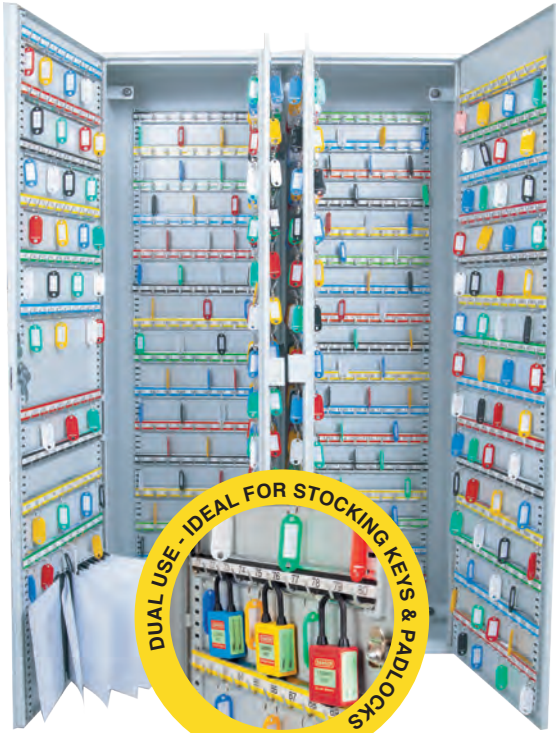

 Heavy gauge steel construction cabinet

- Scratch-resistant finish.
- Full piano length hinge.
- Adjustable color coded hooks with numbers.
- 2 keys with each lock.

CABINET DIMENSIONS: 1300 x 730 x 250mm	CARTON DIMENSIONS: 1360 x 790 x 310mm
GROSS WT: 51.40 kgs.	NET WT: 50.40 kgs.

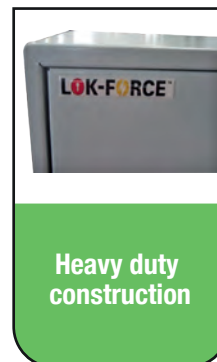
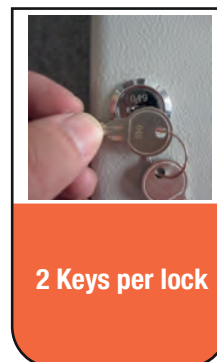
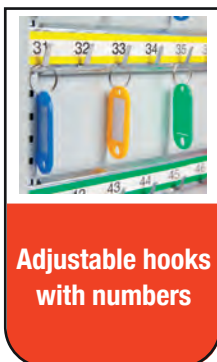
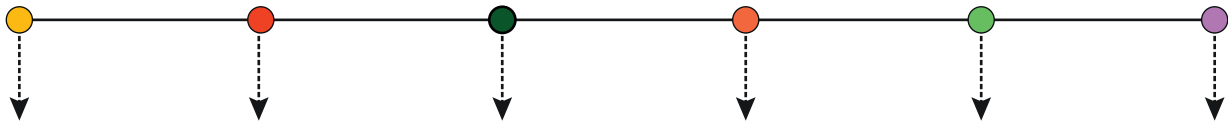

LOTO SAFETY REQUISITES TRADING L.L.C.

Belresheed Warehouse No.7, Next To Jacky's Electronics, Nad Al Hamar, P.O Box 114738, Dubai - UAE

Tel: +971-4-4539779 E-mail: info@lotosafetyproducts.com www.lotosafetyproducts.com

40 DIGITAL KEY CABINET - FEATURES

— Model No: KC-LFDKC-40 —

Manufactured from SPCC cold rolled steel



Heavy gauge steel construction cabinet

- Scratch-resistant finish.
- Full piano length hinge.
- 2 Override Keys with each cabinet.
- Batteries not included.

CARTON DIMENSIONS:

550 x 630 x 370mm

NET WT:
2.20 kgs.

CABINET DIMENSIONS:

270 x 308 x 65mm

GROSS WT:
2.40 kgs.

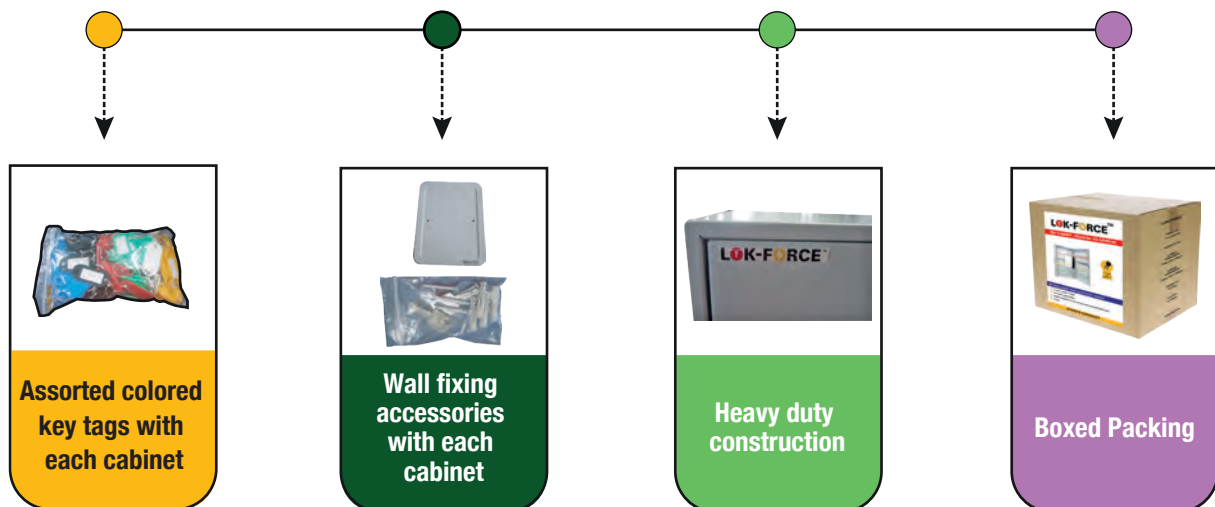

LOTO SAFETY REQUISITES TRADING L.L.C.

Belresheed Warehouse No.7, Next To Jacky's Electronics, Nad Al Hamar, P.O Box 114738, Dubai - UAE

Tel: +971-4-4539779 E-mail: info@lotosafetyproducts.com

www.lotosafetyproducts.com

LOK-FORCE™

60 DIGITAL KEY CABINET - FEATURES

— Model No: KC-LFDKC-60 —

Manufactured from SPCC cold rolled steel



🔑 Heavy gauge steel construction cabinet

- Scratch-resistant finish.
- Full piano length hinge.
- 2 Override Keys with each cabinet.
- Batteries not included.

CARTON DIMENSIONS: 440 x 385 x 495mm	CABINET DIMENSIONS: 432 x 330 x 65mm
NET WT: 3.0 kgs.	GROSS WT: 3.30 kgs.



Assorted colored key tags with each cabinet



Wall fixing accessories with each cabinet



Heavy duty construction



Boxed Packing



LOTO SAFETY REQUISITES TRADING L.L.C.

Belresheed Warehouse No.7, Next To Jacky's Electronics, Nad Al Hamar, P.O Box 114738, Dubai - UAE

Tel: +971-4-4539779 E-mail: info@lotosafetyproducts.com www.lotosafetyproducts.com

120 DIGITAL KEY CABINET - FEATURES

— Model No: KC-LFDKC-120 —

Manufactured from SPCC cold rolled steel



🔑 Heavy gauge steel construction cabinet

- Scratch-resistant finish.
- Full piano length hinge.
- 2 Override Keys with each cabinet.
- Batteries not included.

CARTON DIMENSIONS:	CABINET DIMENSIONS:
455 x 440 x 500mm	375 x 432 x 65mm
NET WT:	GROSS WT:
3.10 kgs.	3.40 kgs.

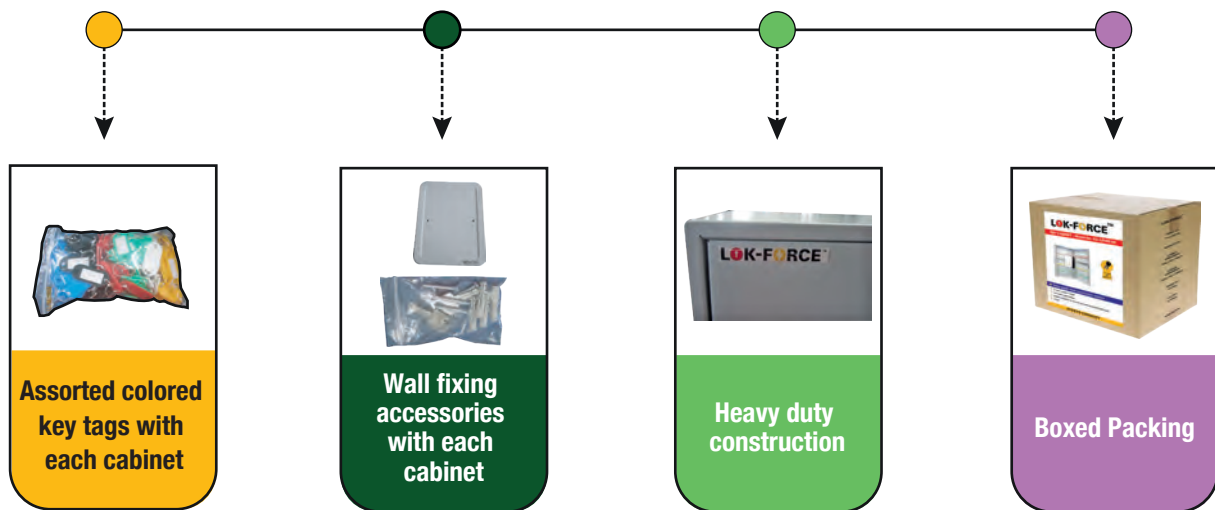

LOTO SAFETY REQUISITES TRADING L.L.C.

Belresheed Warehouse No.7, Next To Jacky's Electronics, Nad Al Hamar, P.O Box 114738, Dubai - UAE

Tel: +971-4-4539779 E-mail: info@lotosafetyproducts.com www.lotosafetyproducts.com

SUGGESTION BOX

— Model No: CAB-SB —

Manufactured from SPCC cold rolled steel



Wall fixing accessories with each cabinet

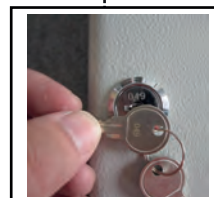

2 Keys per lock



Boxed Packing

Heavy gauge steel construction cabinet

- > Scratch-resistant finish.
- > 2 keys with each lock.

CABINET DIMENSIONS:
215 x 185 x 150mm

CARTON DIMENSIONS:
208 x 170 x 234mm

GROSS WT:
1.60 kgs.

NET WT:
1.50 kgs.



LOTO SAFETY REQUISITES TRADING L.L.C.

Belresheed Warehouse No.7, Next To Jacky's Electronics, Nad Al Hamar, P.O Box 114738, Dubai - UAE

Tel: +971-4-4539779 E-mail: info@lotosafetyproducts.com www.lotosafetyproducts.com

EMERGENCY KEY CABINET

— Model No: KC-LFEKC-3 —

Manufactured from SPCC cold rolled steel

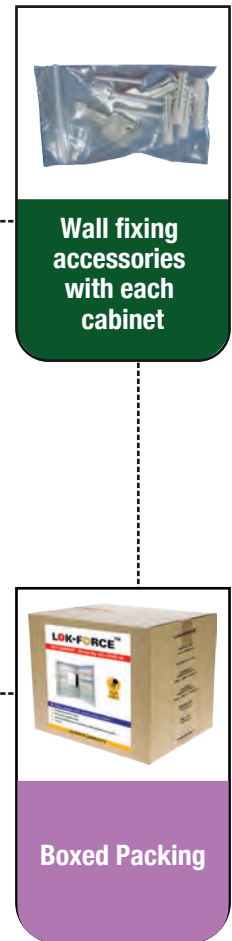

Wall fixing accessories with each cabinet

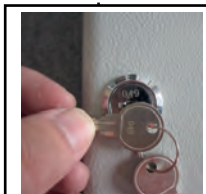

2 Keys per lock



Boxed Packing

Heavy gauge steel construction cabinet

- > Scratch-resistant finish.
- > 2 keys with each lock.

CABINET DIMENSIONS: 120 x 150 x 80mm	No. of key hooks: 3
GROSS WT: 0.60 kgs.	NET WT: 0.55 kgs.



LOTO SAFETY REQUISITES TRADING L.L.C.

Belresheed Warehouse No.7, Next To Jacky's Electronics, Nad Al Hamar, P.O Box 114738, Dubai - UAE

Tel: +971-4-4539779 E-mail: info@lotosafetyproducts.com www.lotosafetyproducts.com

PLASTIC KEY TAGS

MODEL NO.: KT-50

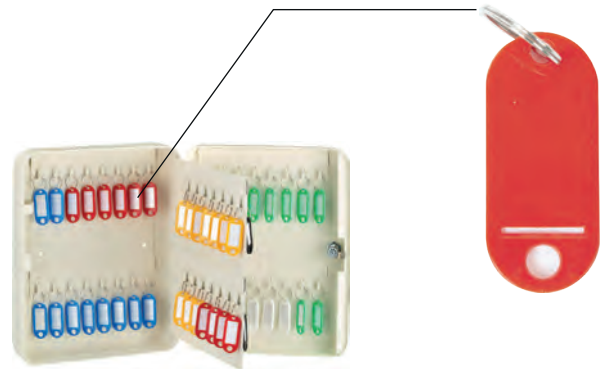

Colors available.: Red, Yellow, Green, Blue, White & Black

MODEL NO.: KT-63



Colors available.: Red, Yellow, Green, Blue, White, Orange & Purple

MODEL NO.: KT-52



Colors available.: White Only



LOTO SAFETY REQUISITES TRADING L.L.C.

Belresheed Warehouse No.7, Next To Jacky's Electronics, Nad Al Hamar, P.O Box 114738, Dubai - UAE

Tel: +971-4-4539779 E-mail: info@lotosafetyproducts.com

www.lotosafetyproducts.com